

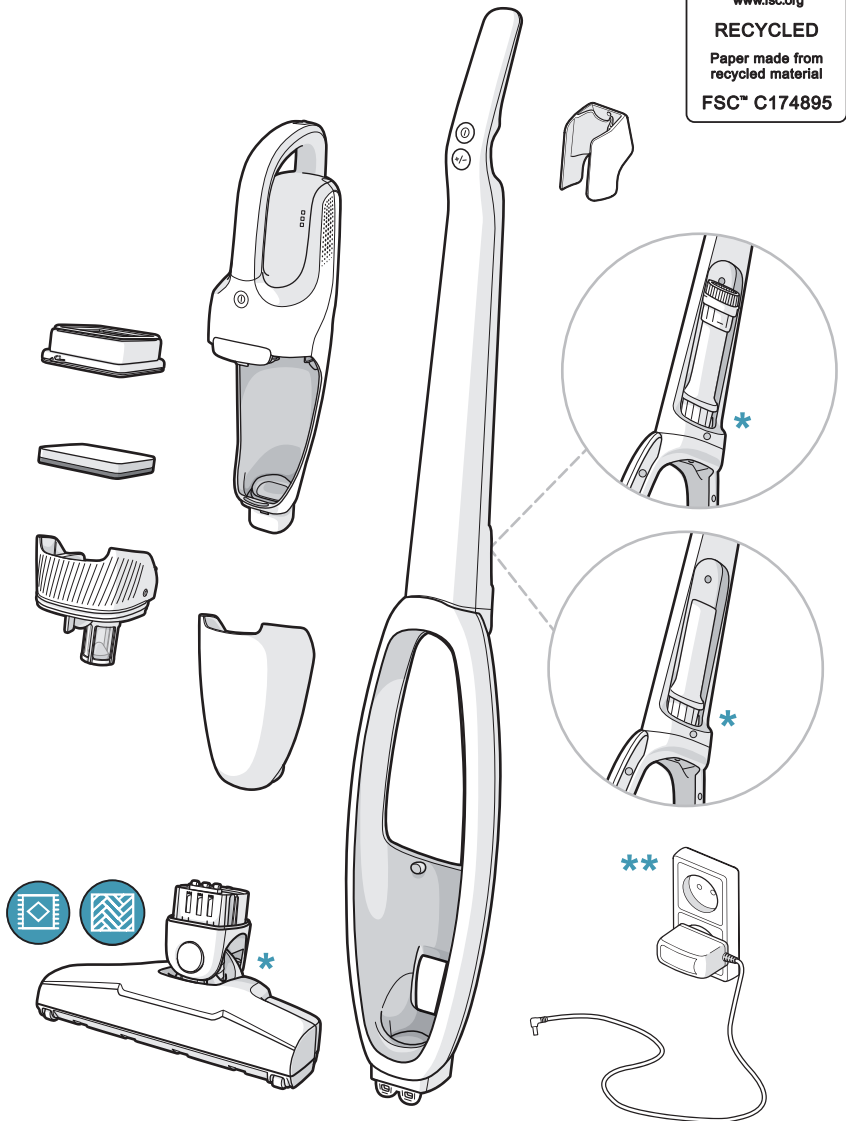

Instruction Book

Clean 300

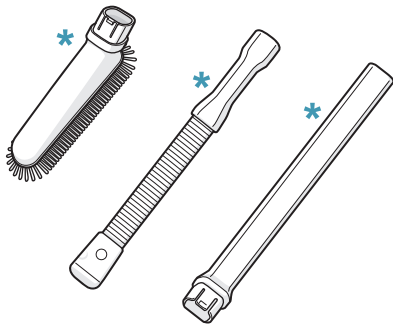

* Accessories may vary from model to model. | Les accessoires peuvent varier d'un modèle à l'autre. | Ausstattung und Zubehör kann je nach Modell variieren. | Accessoires kunnen per model verschillen. | Tillbehören kan variera mellan olika modeller. | Lisävarusteet voivat vaihdella malleittain. | Tilbehør kan variere fra model til model. | Tilbehør kan variere fra modell til modell. | Los accesorios pueden variar según el modelo. | Os acessórios podem variar de modelo para modelo. | Gli accessori possono variare da modello a modello. | Τα εξαρτήματα ίσως διαφέρουν από μοντέλο σε μοντέλο. | Lisad võivad mudelist mudelisse varieeruda. | Priedai kitiems modeliams gali skirtis. | Akcesoria mogą się różnić w zależności od modelu. | Piederumi katram modelim var atšķirties. | Príslušenství se může u jednotlivých modelů lišit. | Doplnky sa môžu lišiť v závislosti od modelu. | Dodaci se mogu razlikovati kod određenih modela. | Nastavki se lahko glede na model razlikujejo. | Принадлежности могут отличаться от модели к модели. | Ці компоненти можуть відрізнятися залежно від моделі. | A tartozékok típusonként eltérőek lehetnek. | Accesorioile pot diferi de la model la model. | Принадлежностите може да се различават според различните модели. | Akseuarla modelden modele farklılık gösterebilir. | درجہ اول لیڈوم نہ فلٹنق شاقفرملا. | Додаци могу да се разликују у зависности од модела усисивача.

www.electrolux.com

** ADS-I3G-22 25013GPG

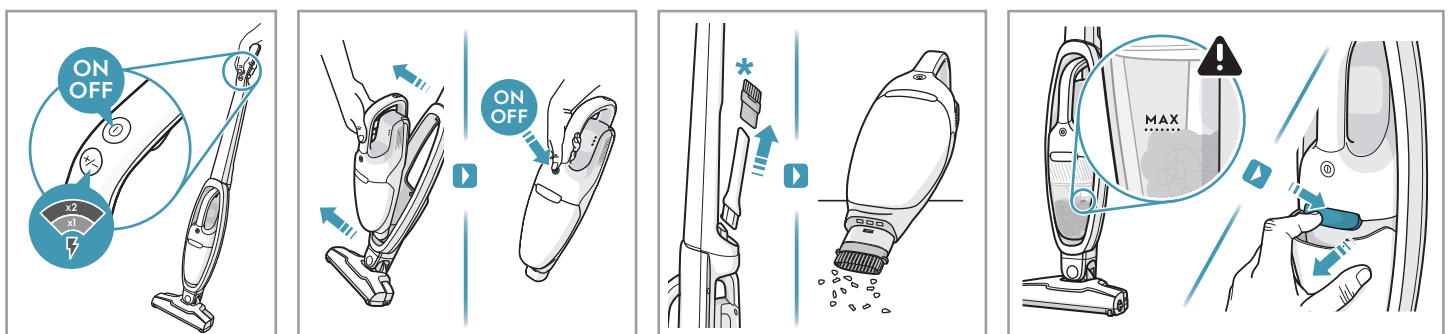
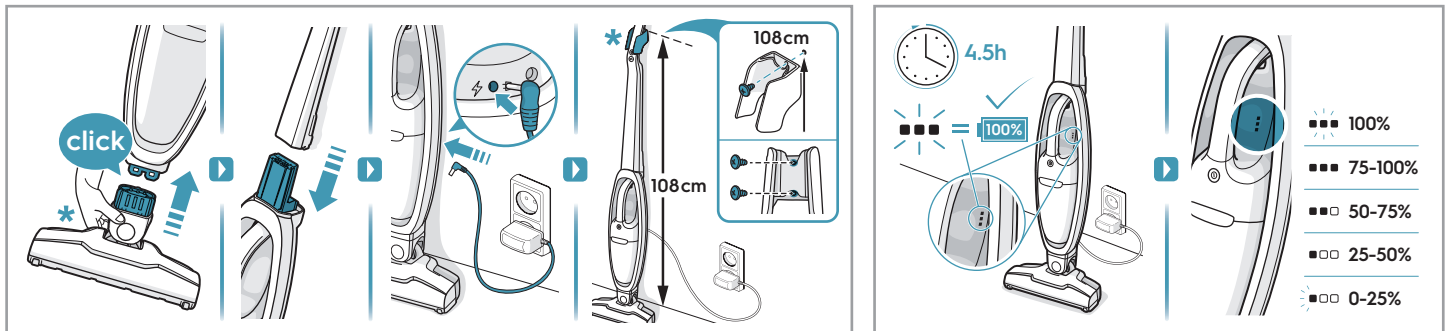

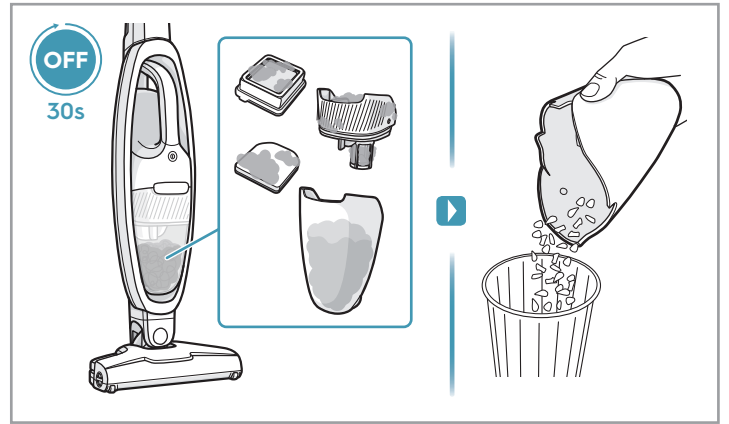
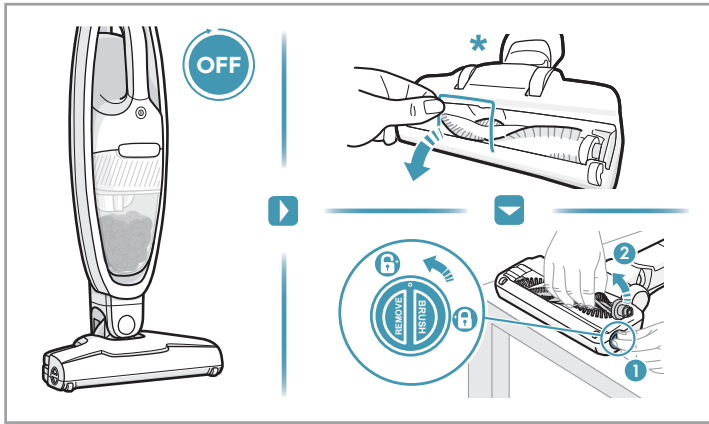
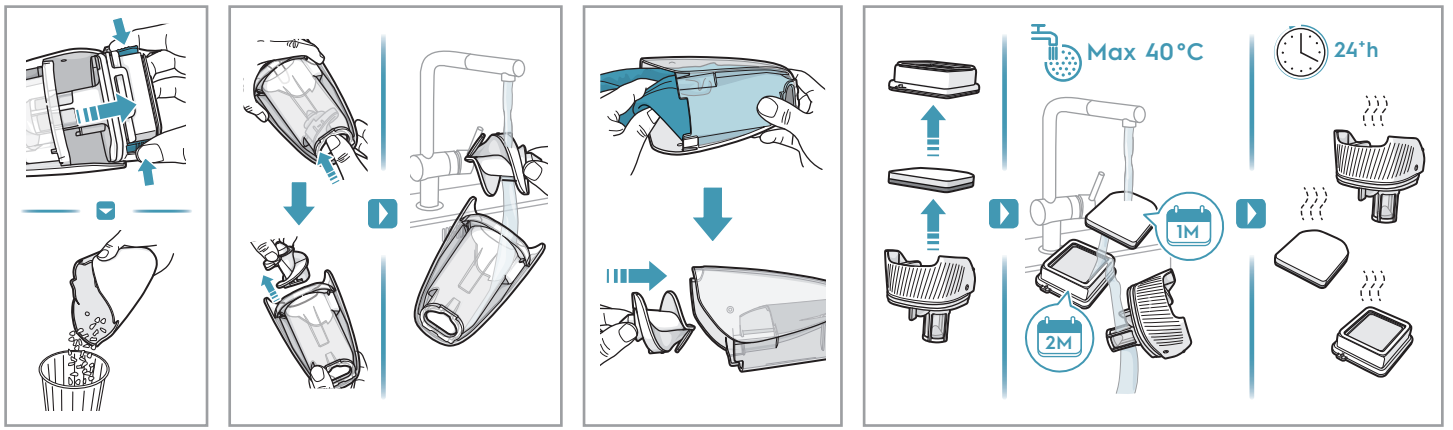

⚠ Please handle battery pack installation with care. The new battery pack must come from Electrolux or an authorized service center.

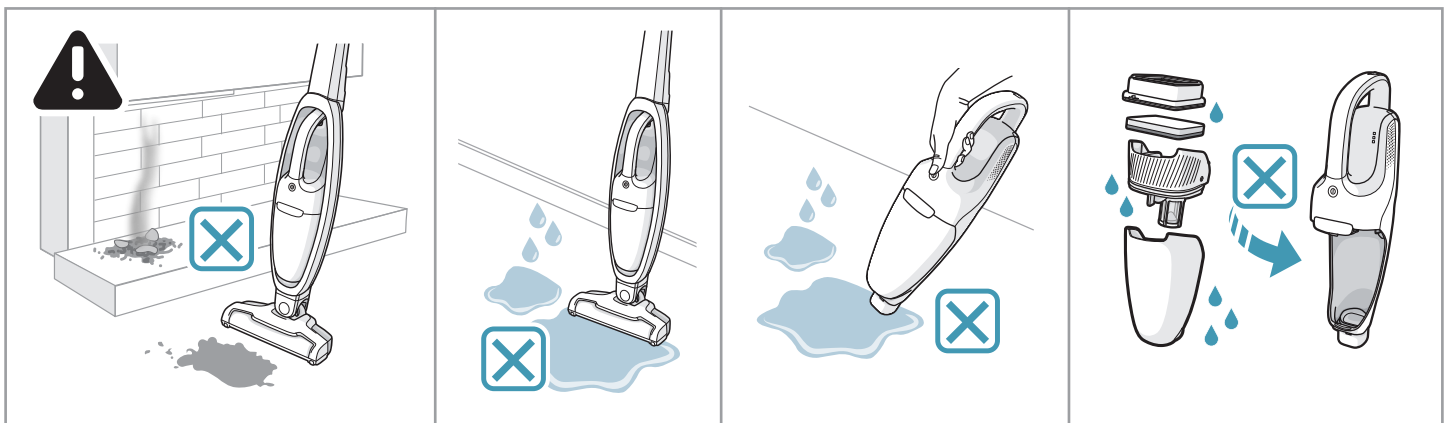
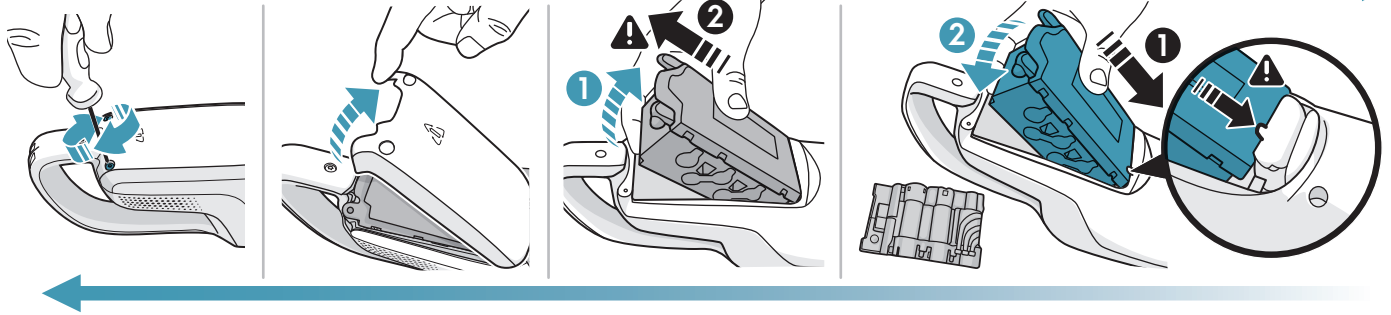

electrolux.com/shop

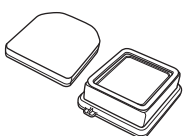

WellQ Performance kit
Commercial Ref: ESKW1
PNC: 900 923 269

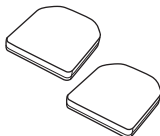

WellQ Filter kit
Commercial Ref: EFKW2
PNC: 900 923 270

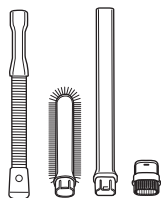

WellQ Home and car kit
Commercial Ref: KIT19
PNC: 900 923 091/4

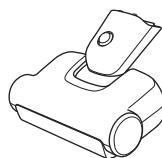

Pet Pro+
Commercial Ref: ZE138
PNC: 900 923 271

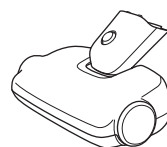

Bed Pro Power+
Commercial Ref: ZE139
PNC: 900 923 272

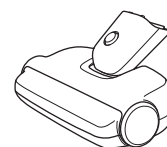

Bed Pro Power UV+
Commercial Ref: ZE139A
PNC: 900 923 273

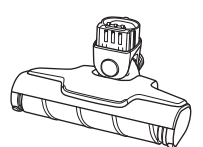

Power Pro
Commercial Ref: ZE137
PNC: 900 923 213