

Omnis Pudding

MECHANICAL GAMING
KEYBOARD

USB

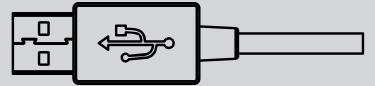

EY5A031 | EY5A032 | EY5A033

 **More at**
www.endorfy.com

Designed by ENDORFY

COOLING SP. Z O.O.
UL. SOKOŁOWSKA 24
05-806 SOKOŁÓW, POLSKA
TEL. +48222920130

  
MADE IN CHINA



We are all *technology* heroes.

- EN:** Volume +/-, mute
- CZ:** Hlasnost +/-, tlumit
- DE:** Lautstärkereglер +/-, stumm schalten
- DK:** Lydstyrkekontrol +/-, lyddes
- ES:** Volumen +/-, silenciар
- FI:** Äänenvoimakkuus +/-, mykistä
- FR:** Volume +/-, mute
- HU:** Hangérszabályozó +/-, némítás
- IT:** Volume +/-, mute
- NO:** Volumkontroll +/-, demp volumet
- PL:** Regulacja głośności +/-, wyciszenie
- RO:** Controlul volumului +/-, dezactivarea sunetului
- RU:** Контроль громкости +/-, отключение звука
- SE:** Volymkontroll +/-, ljudavstängning
- SK:** Hlasnost +/-, stitnit
- UA:** Регулювання гучності +/-, відключення звуку

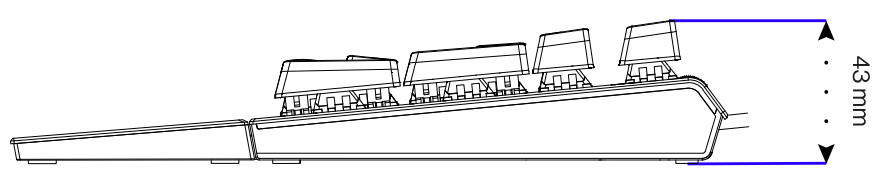
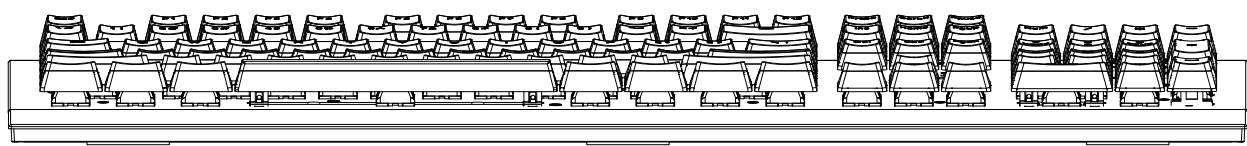
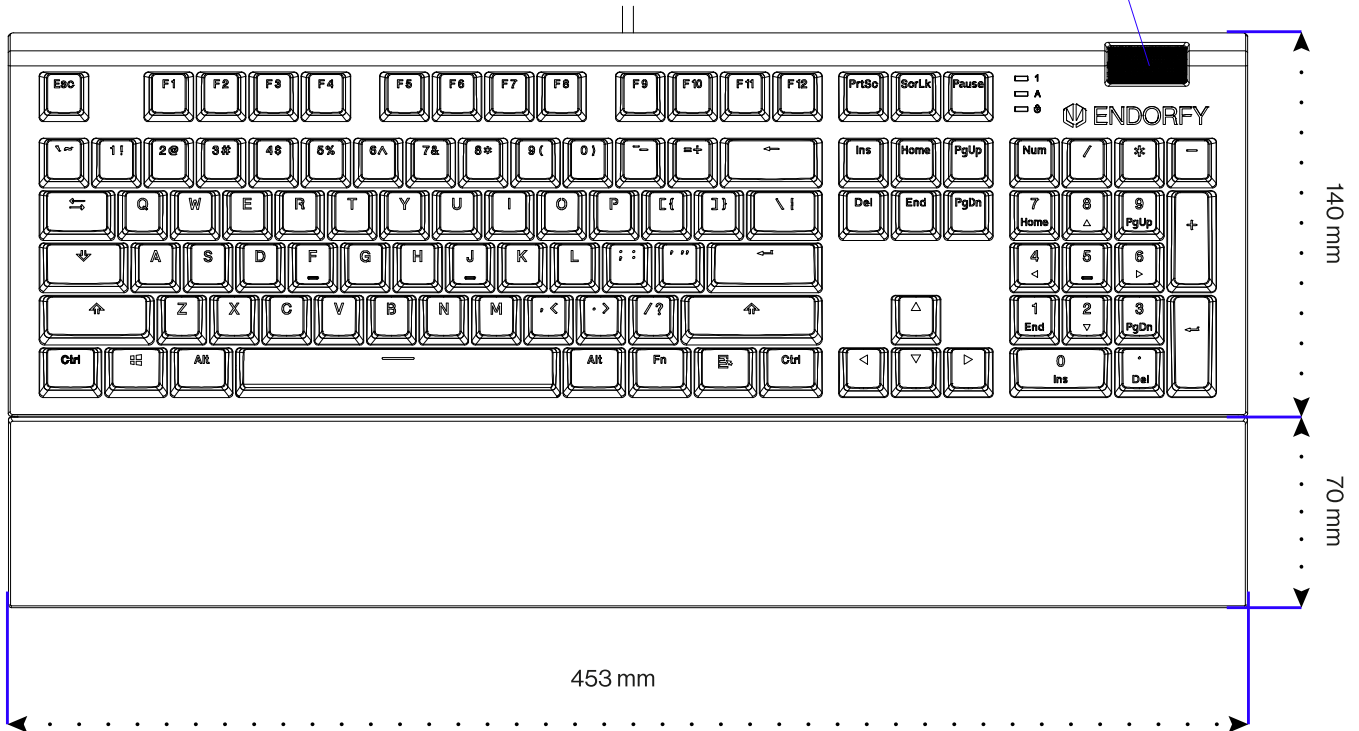

USB

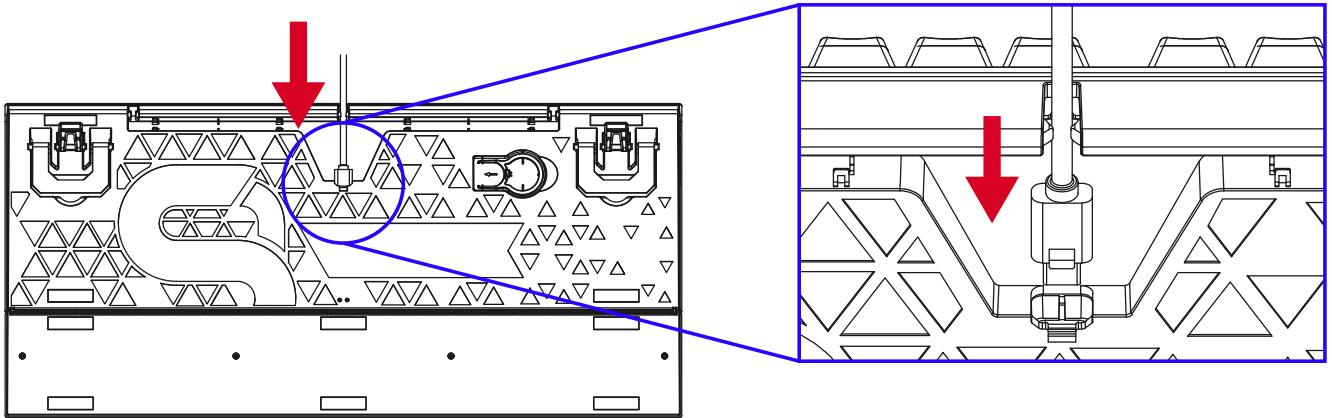
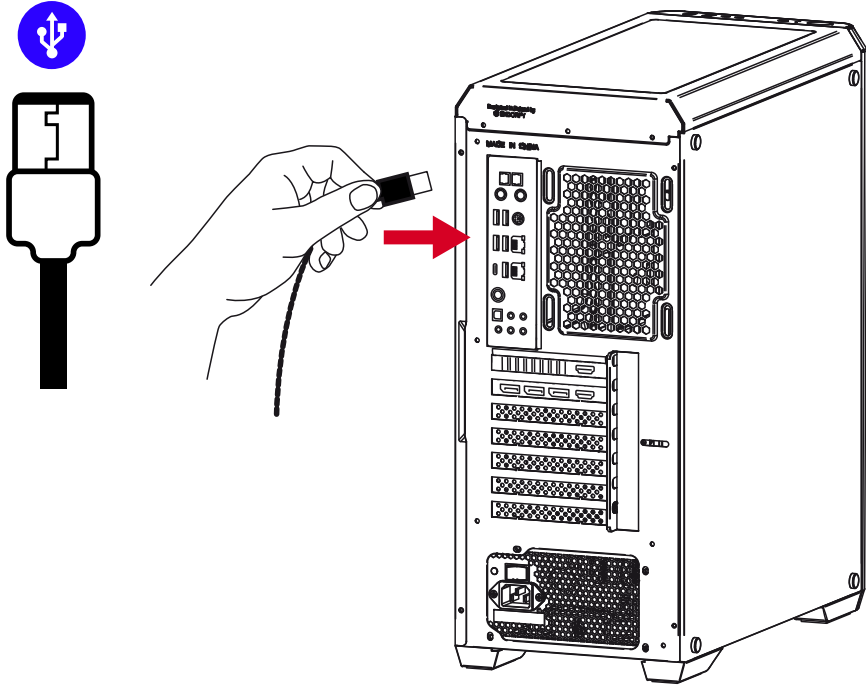



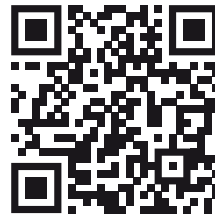
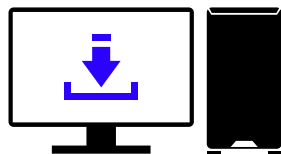



















SOFTWARE







WWW.ENDORFY.COM/SOFTWARE

SOFTWARE/MULTIMEDIA KEYS

-  +  = Computer
-  +  = Web browser
-  +  = Calculator
-  +  = Music player
-  +  = Previous track
-  +  = Next track
-  +  = Play/Pause
-  +  = Stop
-  +  = Mute
-  +  = Volume Down
-  +  = Volume Up

HOTKEYS

-  +  = Gaming mode (WIN Lock)
-  +  = WASD and arrow keys swap

FACTORY RESET

-  +  = Press **[FN]** + (key with the ENDORFY logo) + **[Esc]** for 3 seconds to restore user settings

VOLUME CONTROL WHEEL

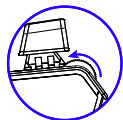

Volume Down

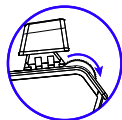



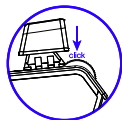







Volume Up















Mute

LED BACKLIGHT EFFECTS

-  +   = Lighting brightness up/down
-  +   = Backlight effect speed
-  +   = Effect direction
-  +  = Backlight colour change

LED BACKLIGHT EFFECTS

-  +  = Modes 1-3
-  +  = Modes 4-6
-  +  = Modes 7-9
-  +  = Modes 10-12
-  +  = Modes 13-15
-  +  = Modes 16-18





CREATING A CUSTOM BACKLIT MODE

1. Press **[FN]** (key with the ENDORFY logo) + **[`-]** to enter the user mode.
2. In user mode, press **[FN]** + **[`-]** again to enter edit mode (the LED indicators will start to blink). Click any buttons to turn LEDs on/off. Switch between colors using **[FN]** + **[=+]**. You can switch off key LED completely while is not blinking. Make you own LED combination.
3. Press **[FN]** + **[`-]** to save the user mode, indicator LEDs will stop blinking.

SOFTWAROVÉ/MULTIMEDIÁLNÍ KLÁVESY

	+		= Počítač
	+		= Webový Prohlížeč
	+		= Kalkulačka
	+		= Hudební Přehrávač
	+		= Předchozí Audio Stopa
	+		= Následující Audio Stopa
	+		= Play/Pause
	+		= Stop
	+		= Ztlumit
	+		= Snížení hlasitosti
	+		= Zvýšení hlasitosti

ZKRATKY

	+		= Herní režim (Uzamčení klávesy WIN)
	+		= Prohození WASD a šipek

RESET DO TOVÁRNÍHO NASTAVENÍ

	+		= Stisknutím [FN] (klávesa s logem ENDORFY) + [Esc] po dobu 3 sekund obnovíte nastavení uživatele.
---	---	---	--

ROLOVACÍ KOLEČKO HLASITOSTI



Snížení hlasitosti





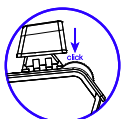







Zvýšení hlasitosti















Ztlumit

EFEKTY PODSVÍCENÍ

	+			= Jas podsvícení větší/menší
	+			= Rychlost efektu podsvícení
	+			= Směr efektu
	+			= Změna barvy podsvícení























18 EFEKTŮ PODSVÍCENÍ

	+		= Režim 1-3
	+		= Režim 4-6
	+		= Režim 7-9
	+		= Režim 10-12
	+		= Režim 13-15
	+		= Režim 16-18





VYTVOŘENÍ VLASTNÍHO REŽIMU PODSVÍCENÍ

1. Stisknutím **[FN]** (klávesa s logem ENDORFY) + **[^-]** vstoupíte do uživatelského režimu.
2. V uživatelském režimu opětovným stisknutím kláves **[FN]** + **[^-]** přejdete do režimu úprav (indikátory LED začnou blikat). Stisknutím libovolného tlačítka zapnete/vypnete podsvícení. Chcete-li změnit barvu, stiskněte **[FN]** + **[=+]**. Opakujte výběr barvy pro všechna tlačítka, která se mají podsvětlit.
3. Stisknutím **[FN]** + **[^-]** uložíte uživatelský režim, indikátory LED přestanou blikat.

MULTIMEDIA-/PROGRAMMTASTEN

	+		= Computer
	+		= Web-Browser
	+		= Rechner
	+		= Musik-Player
	+		= Vorheriger Titel
	+		= Nächster Titel
	+		= Abspielen / Pause
	+		= Anhalten
	+		= Stumm schalten
	+		= Leiser
	+		= Lauter

HOTKEYS

	+		= Spielmodus (Windows-Tastensperre)
	+		= Umstellen von WASD und Pfeiltasten

AUF WERKSEINSTELLUNGEN ZURÜCKSETZEN

	+		= Drücken Sie [FN] (Taste mit dem ENDORFY-Logo) + [Esc] für 3 Sekunden, um die Benutzermodi wiederherzustellen.
---	---	---	---

LAUTSTÄRKEWALZE



Volumave Down

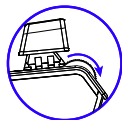



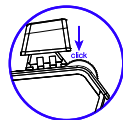







Lauter















Stumm schalten

LED-HINTERGRUNDBELEUCHTUNG

	+			= Erhöhen / Verringern der Helligkeit
	+			= Geschwindigkeit der Hintergrundbeleuchtungseffekte
	+			= Richtungsänderung des Effekts
	+			= Änderung der Hintergrundbeleuchtungsfarbe























18 HINTERGRUNDBELEUCHTUNGSEFFEKTE

	+		= Modi 1-3
	+		= Modi 4-6
	+		= Modes 7-9
	+		= Modes 10-12
	+		= Modes 13-15
	+		= Modes 16-18





ERSTELLEN ODER MODIFIZIEREN DES BENUTZERMODUS

1. Drücken Sie **[FN]** (Taste mit dem ENDORFY-Logo) + **[^-]**, um die Benutzermodi aufzurufen.
2. Drücken Sie im Benutzermodus erneut **[FN]** + **[^-]**, um in den Bearbeitungsmodus zu gelangen (die LED-Anzeigen beginnen zu blinken).
Drücken Sie eine beliebige Taste, um die Hintergrundbeleuchtung ein- oder auszuschalten. Um die zugewiesene Farbe zu ändern, drücken Sie **[FN]** + **[=+]**. Wiederholen Sie die Farbauswahl für alle Tasten, die hintergrundbeleuchtet werden sollen.
3. Drücken Sie **[FN]** + **[^-]**, um den Benutzermodus zu speichern, die LED-Anzeigen hören auf zu blinken.

MULTIMEDIA TASTER / PROGRAMTASTER

	+		= Computer
	+		= Browser
	+		= Lommeregner
	+		= Musikafspiller
	+		= Forrige musikstykke
	+		= Næste musikstykke
	+		= Afspil / Pauser
	+		= Stop
	+		= Lydløs
	+		= Stille
	+		= Højere

HOTKEYS

	+		= Spiltilstand (Blokade af Windows-tast)
	+		= Ændring af WASD og retningstaster (piletaster)

NULSTILLING AF FABRIKSINDSTILLINGER

	+		= Tryk på [FN] (tast med ENDORFY-logo) + [Esc] i 3 sekunder for at gendanne brugerindstillingerne.
---	---	---	--

LYDSTYRKE-RULLE



Stille

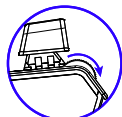



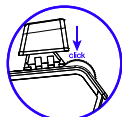







Højere















Lydløs

LED BELYSNING

	+			= Forøgelse / formindskelse af lysstyrke
	+			= Hastighed af belysningseffekter
	+			= Ændring af effektens retning
	+			= Ændring af belysningens farve



18 BELYSNINGSEFFEKTER

	+		= 1-3 tilstande
	+		= 4-6 tilstande
	+		= 7-9 tilstande
	+		= 10-12 tilstande
	+		= 13-15 tilstande
	+		= 16-18 tilstande





DANNELSE ELLER MODIFCERING AF BRUGERTILSTAND

1. Tryk på **[FN]** (tast med ENDORFY-logo) + **[^-]** for at gå ind i brugertilstande.
2. Mens du er i brugertilstand, skal du trykke på **[FN]** + **[^-]** igen for at gå ind i redigeringsstilstand (LED-indikatorerne begynder at blinke). Tryk på en vilkårlig knap for at tænde/slukke for baggrundsbelysningen på den. For at ændre den tildelte farve skal du trykke på **[FN]** + **[=+]**. Gentag farvevalget for alle de knapper, der skal belyses.
3. Tryk på **[FN]** + **[^-]** for at gemme brugertilstanden, LED-indikatorerne holder op med at blinke.



TECLAS MULTIMEDIA/PROGRAMABLES

	+		= Ordenador
	+		= Navegador de internet
	+		= Calculadora
	+		= Reproductor de música
	+		= Anterior canción
	+		= Siguiente canción
	+		= Reproducir / Pausa
	+		= Detener
	+		= Silenciar
	+		= Bajar volumen
	+		= Subir volumen

HOTKEYS

	+		= Modo de juego (Bloqueo de la tecla Windows)
	+		= Cambio de WASD y teclas de dirección (flechas)

RESTABLECER LOS AJUSTES DE FÁBRICA

	+		= Presiona [FN] (tecla con el logo ENDORFY) + [Esc] durante 3 segundos para restablecer los ajustes del usuario.
---	---	---	--

RODILLO DE VOLUMEN

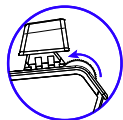

Bajar volumen

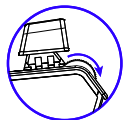



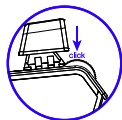









Subir volumen















Silenciar

ILUMINACIÓN LED

	+			= Aumentar / reducir brillo
	+			= Velocidad de los efectos de iluminación
	+			= Cambio de la dirección del efecto
	+			= Cambio de color de la iluminación

18 EFECTOS DE ILUMINACIÓN

	+		= Modos 1-3
	+		= Modos 4-6
	+		= Modos 7-9
	+		= Modos 10-12
	+		= Modos 13-15
	+		= Modos 16-18





CREACIÓN O MODIFICACIÓN DE UN MODO DEL USUARIO

1. Presiona **[FN]** (tecla con el logo ENDORFY) + **[^-]** para entrar en el modo de usuario.
2. Estando en el modo de usuario presiona otra vez **[FN]** + **[^-]** para entrar en el modo de edición (los indicadores LED comienzan a parpadear). Presiona cualquier tecla para encender/apagar la retroiluminación en ella. Para cambiar el color asignado presiona **[FN]** + **[=+]**. Repite la selección del color para todas las teclas que deban ser retroiluminadas.
3. Presiona **[FN]** + **[^-]** para guardar el modo de usuario, los indicadores LED dejan de parpadear.



MULTIMEDIA-/OHJELMANÄPPÄIMET

	+		= Tietokone
	+		= Internet-selain
	+		= Laskin
	+		= Musiikkisoitin
	+		= Edellinen kappale
	+		= Seuraava kappale
	+		= Toista / Tauko
	+		= Pidätä
	+		= Mykistä
	+		= Hiljennä
	+		= Voimista

HOTKEYS

	+		= Pelitila (Windows näppäimen lukitus)
	+		= Vaihda WASD ja suuntanäppäimet (nuolet)

TEHDASASETUSTEN PALAUTUS

	+		= Paina [FN] (näppäin, jossa on ENDORFY-logo) + [Esc] 3 sekunnin ajan palauttaaksesi käyttäjäasetukset.
---	---	---	---

ÄÄNENVOIMAKKUUDEN SÄÄTÖRULLA



Hiljennä





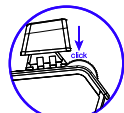







Voimista















Mykistä

LED TAUSTAVALO

	+			= Kirkkauden lisäys / vähennys
	+			= Taustavaloefektien nopeus
	+			= Efektin suunnan vaihto
	+			= Taustavalon värin muutos

18 TAUSTAVALOEFEKTIÄ

	+		= Tilat 1-3
	+		= Tilat 4-6
	+		= Tilat 7-9
	+		= Tilat 10-12
	+		= Tilat 13-15
	+		= Tilat 16-18

KÄYTTÄJÄN TILAN LUONTI TAI MUOKKAUS

1. Paina **[FN]** (näppäin, jossa on ENDORFY-logo) + **[`-]** siirtyäksesi käyttäjätiloihin.
2. Kun olet käyttäjätilassa, paina **[FN]** + **[`-]** uudelleen siirtyäksesi muokkaustilaan (LED-merkkivalot alkavat vilkkua). Paina mitä tahansa painiketta kytkeäksesi taustavalon päälle/pois päältä. Voit vaihtaa määritettyä väriä painamalla **[FN]** + **[=+]**. Toista väriä valinta kaikille painikkeille, jotka halutaan valaista.
3. Paina **[FN]** + **[`-]** tallentaaksesi käyttäjätilan, LED-merkkivalot lakkaavat vilkkumasta.

TOUCHES DE MÉDIAS/DE LOGICIEL

- = Ordinateur
- = Navigateur Web
- = Calculatrice
- = Lecteur de musique
- = Précédent
- = Suivant
- = Lecture / Pause
- = Arrêter
- = Mute
- = Baisser le son
- = Augmenter le son

HOTKEYS

- = Mode jeu (verrouillage de la touche Windows)
- = WASD et conversion des touches fléchées

REMISE AUX PARAMÈTRES D'USINE

- = Appuyez sur **[FN]** (touche avec le logo ENDORFY) + **[Esc]** pendant 3 secondes pour restaurer les paramètres de l'utilisateur.

ROULEAU DE CONTRÔLE DU VOLUME

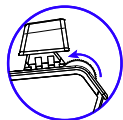

Baisser le son

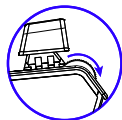

Augmenter le son

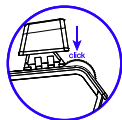

Mute

ÉCLAIRAGE LED

- = Augmenter / diminuer la luminosité
- = Vitesse des effets de l'éclairage
- = Changement de la direction de l'effet
- = Changement de la couleur de l'éclairage

18 EFFETS DE L'ÉCLAIRAGE

- = Modes 1-3
- = Modes 4-6
- = Modes 7-9
- = Modes 10-12
- = Modes 13-15
- = Modes 16-18





CRÉATION OU LA MODIFICATION DU MODE D'UTILISATION

1. Appuyez sur **[FN]** (touche avec le logo ENDORFY) + **[^-]** pour accéder aux modes utilisateur.
2. En mode utilisateur, appuyez à nouveau sur **[FN]** + **[^-]** pour accéder au mode d'édition (les indicateurs LED se mettent à clignoter). Appuyez sur n'importe quel bouton pour activer/désactiver le rétro-éclairage de celui-ci. Appuyez sur **[FN]** + **[=+]** pour modifier la couleur attribuée. Répétez la sélection de la couleur pour tous les boutons à rétro-éclairer.
3. Appuyez sur **[FN]** + **[^-]** pour enregistrer le mode utilisateur, les indicateurs LED cessent de clignoter.

MULTIMÉDIA/PROGRAM BILLENTŰK

	+		= Számítógép
	+		= Webböngésző
	+		= Számológép
	+		= Zenelejátszó
	+		= Előző szám
	+		= Következő szám
	+		= Lejátszás / Szünet
	+		= Leállítás
	+		= Némitás
	+		= Halkítás
	+		= Hangosítás

HOTKEYS

	+		= Játékmód (Windows billentyűzárolás)
	+		= A WASD és az iránygombok (nyilak) cseréje

GYÁRI BEÁLLÍTÁSOK VISSZAÁLLÍTÁSA

	+		= A felhasználói beállítások visszaállításához tartsa benyomva az [FN] -t (az ENDORFY logós billentyű) + az [Esc] -et 3 másodpercig.
---	---	---	--

HANGERŐSZABÁLYZÓ GÖRGŐ



Halkítás





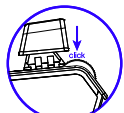







Hangosítás















Némitás

LED HÁTTÉRVILÁGÍTÁS

	+			= Fényerő növelése / csökkentése
	+			= Háttérvilágítás effektus sebessége
	+			= Az effektus irányának megváltoztatása
	+			= Háttérvilágítás színének módosítása

18 HÁTTÉRVILÁGÍTÁSI EFFEKTUS

	+		= 1-3. üzemmódok
	+		= 4-6. üzemmódok
	+		= 7-9. üzemmódok
	+		= 10-12. üzemmódok
	+		= 13-15. üzemmódok
	+		= 16-18. üzemmódok





FELHASZNÁLÓI ÜZEMMÓD LÉTREHOZÁSA VAGY MÓDOSÍTÁSA

1. A felhasználói üzemmódkba történő belépéshez nyomd meg az **[FN]**-t (ENDORFY logós billentyű) + a **[^-]**-t.
2. A felhasználói üzemmódban nyomd meg még egyszer az **[FN]** + **[^-]**-t a beállítási üzemmódba történő belépéshez (a LED jelzőfények villogni kezdenek).
Nyomj meg egy szabadon választott billentyűt a megvilágítása be/kikapcsolásához. A hozzárendelt szín megváltoztatásához nyomd meg a **[FN]** + **[=+]**-t. Ismételd meg a színválasztást az összes megvilágítandó billentyű tekintetében.
3. Nyomd meg a **[FN]** + **[^-]**-t a felhasználói mód mentéséhez, a LED jelzőfények megszűnnek villogni.

TASTI MULTIMEDIALI/SOFTWARE

	+		=	Computer
	+		=	Web browser
	+		=	Calcolatrice
	+		=	Lettore musicale
	+		=	Brano precedente
	+		=	Brano successivo
	+		=	Riproduci / Pausa
	+		=	Stop
	+		=	Mute
	+		=	Diminuisci volume
	+		=	Aumenta volume

HOTKEYS

	+		=	Modalità gioco (Blocco del tasto Windows)
	+		=	Modifica del WASD e dei tasti direzionali (freccie)

RESET ALLE IMPOSTAZIONI DI FABBRICA

	+		=	<p>Premere [FN] (tasto con logo ENDORFY) + [Esc] per 3 secondi per ripristinare le impostazioni utente.</p>
---	---	---	---	---

RULLO DEL VOLUME



Diminuisci volume

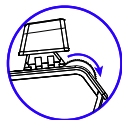



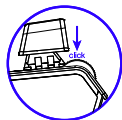







Aumenta volume















Mute

RETROILLUMINAZIONE LED

	+		+		=	Aumento / diminuzione della luminosità
	+		+		=	Velocità degli effetti di retroilluminazione
	+		=	Modifica della direzione dell'effetto		
	+		=	Modifica del colore di retroilluminazione		

18 EFFETTI DI RETROILLUMINAZIONE

	+		=	Modalità 1-3
	+		=	Modalità 4-6
	+		=	Modalità 7-9
	+		=	Modalità 10-12
	+		=	Modalità 13-15
	+		=	Modalità 16-18





CREAZIONE O MODIFICA DELLA MODALITÀ UTENTE

1. Premere **[FN]** (tasto con logo ENDORFY) + **[^-]** per accedere alla modalità utente.
2. In modalità utente, premere di nuovo **[FN]** + **[^-]** per accedere alla modalità di modifica (gli indicatori LED lampeggeranno). Premere qualsiasi pulsante per accendere/spingere la retroilluminazione. Per modificare il colore attribuito, premere **[FN]** + **[=+]**. Ripetere la selezione del colore per tutti i pulsanti che si desidera illuminare.
3. Premere **[FN]** + **[^-]** per salvare la modalità utente, gli indicatori LED smetteranno di lampeggiare.

MULTIMEDIATASTER / PROGRAMTASTER

	+		= Datamaskin
	+		= Nettleser
	+		= Kalkulator
	+		= Musikkavspiller
	+		= Spill forrige sang
	+		= Spill neste sang
	+		= Spill/pause
	+		= Stopp
	+		= Demp volumet
	+		= Senk volumet
	+		= Øk volumet

HOTKEYS

	+		= Spillmodus (Windows-tast deaktivert)
	+		= Bytting mellom WASD og retningstaster (piltaster)

NULLSTILL TIL FABRIKKINNSTILLINGER

	+		= Trykk på [FN] (tasten med ENDORFY-logoen) + [Esc] og hold trykket i 3 sekunder for å gjenopprette brukerinnstillingene.
---	---	---	---

VOLUMRULLE

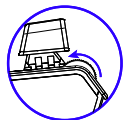

Senk volumet

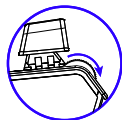



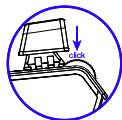







Øk volumet















Demp volumet

LED BAKGRUNNSBELYSNING

	+			= Øk / reduser lysstyrken
	+			= Hastighet av bakgrunnsbelysningseffekter
	+			= Endring av effektens retning
	+			= Endring av bakgrunnsbelysningsfarge

18 BAKGRUNNSBELYSNINGSEFFEKTER

	+		= Modus 1-3
	+		= Modus 4-6
	+		= Modus 7-9
	+		= Modus 10-12
	+		= Modus 13-15
	+		= Modus 16-18

OPPRETTING ELLER MODIFISERING AV BRUKERMODUS

1. Trykk **[FN]** (tast med ENDORFY-logo) + **[· ~]** for å gå inn i brukermodus.

Mens du er i brukermodus, trykk **[FN]** + **[· ~]** igjen for å gå inn i

2. redigeringsmodus (LED-indikatorer vil blinke).

Trykk på en valgfri knapp for å slå på/av bakgrunnsbelysningen på den.





For å endre den tilordnede fargen, trykk **[FN]** + **[=+]**. Gjenta fargevalget for alle knappene som skal ha bakgrunnsbelysning.

3. Trykk på **[FN]** + **[· ~]** for å lagre brukermodus, LED-indikatorer vil slutte å blinke.

▶▶▶ **KLAWISZE MULTIMEDIALNE/PROGRAMOWE**

-  +  = Komputer
-  +  = Przeglądarka internetowa
-  +  = Kalkulator
-  +  = Odtwarzacz muzyki
-  +  = Poprzednia
-  +  = Następna
-  +  = Play/Pause
-  +  = Stop
-  +  = Wyciszenie
-  +  = Ciszej
-  +  = Głośniej

▶▶▶ **SKRÓTY KLAWISZOWE**

-  +  = Tryb gry (blokada klawisza Windows)
-  +  = Zamiana WASD i strzałek

▶▶▶ **RESET DO USTAWIEŃ FABRYCZNYCH**

-  +  = Naciśnij **[FN]** (klawisz z logo ENDORFY) + **[Esc]** przez 3 sekundy, żeby przywrócić ustawienia użytkownika.

▶▶▶ **ROLKA REGULACJI GŁOŚNOŚCI**



Ciszej





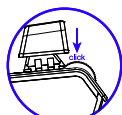







Głośniej















Wyciszenie

▶▶▶ **PODŚWIETLENIE LED**

-  +   = Zwiększenie/zmniejszenie jasności
-  +   = Prędkość efektów podświetlenia
-  +  = Zmiana kierunku efektu
-  +  = Zmiana koloru podświetlenia

▶▶▶ **18 EFEKTÓW PODŚWIETLENIA**

-  +  = Tryby 1-3
-  +  = Tryby 4-6
-  +  = Tryby 7-9
-  +  = Tryby 10-12
-  +  = Tryby 13-15
-  +  = Tryby 16-18





▶▶▶ **TWORZENIE LUB MODYFIKOWANIE TRYBU UŻYTKOWNIKA**

1. Naciśnij **[FN]** (klawisz z logo ENDORFY) + **[^-]**, żeby wejść w tryby użytkownika.
2. Będąc w trybie użytkownika jeszcze raz naciśnij **[FN]** + **[^-]**, aby wejść w tryb edycji (wskaźniki LED zaczną migać).
Naciskaj dowolny przycisk, żeby włączyć/wyłączyć na nim podświetlenie. W celu zmiany przypisywanego koloru naciskaj **[FN]** + **[=+]**. Powtórz wybór koloru dla wszystkich przycisków, które mają być podświetlone.
3. Naciśnij **[FN]** + **[^-]**, żeby zapisać tryb użytkownika, wskaźniki LED przestaną migać.

▶▶▶ TASTE MULTIMEDIA/DE PROGRAMARE

	+		=	Computer
	+		=	Browser web
	+		=	Calculator
	+		=	Player muzical
	+		=	Piesa anterioară
	+		=	Piesa următoare
	+		=	Redare / Pauză
	+		=	Stopează
	+		=	Dezactivarea sunetului
	+		=	Volum redus
	+		=	Volum ridicat

▶▶▶ HOTKEYS

	+		=	Modul de joc (Blocarea tastei Windows)
	+		=	Modificarea WASD și a tastelor de direcție (săgeți)

▶▶▶ REVENIRE LA SETĂRILE DIN FABRICĂ

	+		=	Apăsați [FN] (tasta cu logo-ul ENDORFY) + [Esc] timp de 3 secunde pentru a restabili setările utilizatorului.
---	---	---	---	---

▶▶▶ ROLĂ VOLUM SUNET



Volum redus





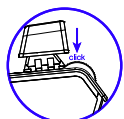







Volum ridicat















Dezactivarea sunetului

▶▶▶ LUMINĂ DE FUNDAL LED

	+			=	Mărirea / micșorarea luminozității
	+			=	Viteza efectelor luminii de fundal
	+			=	Modificarea direcției efectului
	+			=	Modificarea culorii luminii de fundal

▶▶▶ 18 EFECTE DE LUMINĂ DE FUNDAL

	+		=	Moduri 1-3
	+		=	Moduri 4-6
	+		=	Moduri 7-9
	+		=	Moduri 10-12
	+		=	Moduri 13-15
	+		=	Moduri 16-18

▶▶▶ CREAREA SAU MODIFICAREA MODULUI UTILIZATORULUI

1. Apasă **[FN]** (tasta cu logo-ul ENDORFY) + **[^-]** pentru a intra în modurile utilizatorului.
2. În timp ce te afli în modul de utilizator, apasă din nou **[FN]** + **[^-]** pentru a intra în modul de editare (indicatoarele LED vor începe să clipească). Apasă orice buton pentru a porni/opri lumina de fundal. Pentru a schimba culoarea atribuită, apasă **[FN]** + **[=+]**. Repetă selecția culorii pentru toate butoanele care urmează să fie iluminate.
3. Apasă **[FN]** + **[^-]** pentru a salva modul de utilizare, indicatoarele LED vor înceta să mai clipească.

▶▶▶ МУЛЬТИМЕДИЙНЫЕ/ПРОГРАММНЫЕ КНОПКИ

- = Компьютер
- = Интернет-браузер
- = Калькулятор
- = Музыкальный проигрыватель
- = Предыдущая песня
- = Следующая песня
- = Следующая песня
- = Стоп
- = Отключение звука
- = Уменьшение громкости
- = Увеличение громкости

▶▶▶ HOTKEYS

- = Игровой режим (блокировка клавиши Windows)
- = Замена WASD и клавиш перемещения (стрелок)

▶▶▶ СБРОС К ЗАВОДСКИМ НАСТРОЙКАМ

- = Нажать **[FN]** (клавиша с логотипом ENDORFY) + **[Esc]** и удерживать в течение 3 секунд, чтобы сбросить пользовательские настройки.

▶▶▶ РОЛИК РЕГУЛИРОВКИ ГРОМКОСТИ

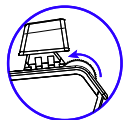

Уменьшение громкости

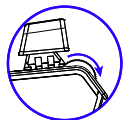

Увеличение Громкости

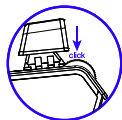

Отключение звука

▶▶▶ СВЕТОДИОДНАЯ ПОДСВЕТКА

- = Увеличение / уменьшение яркости
- = Скорость эффектов подсветки
- = Изменение направления эффекта
- = Изменение цвета подсветки

▶▶▶ 18 ЭФФЕКТОВ ПОДСВЕТКИ

- = Режимы 1-3
- = Режимы 4-6
- = Режимы 7-9
- = Режимы 10-12
- = Режимы 13-15
- = Режимы 16-18





▶▶▶ СОЗДАНИЕ ИЛИ ИЗМЕНЕНИЕ ПОЛЬЗОВАТЕЛЬСКОГО РЕЖИМА

1. Нажать **[FN]** (клавиша с логотипом ENDORFY) + **[~]** для входа в пользовательские режимы.
2. В пользовательском режиме нажать **[FN]** + **[~]** еще раз, чтобы войти в режим редактирования (светодиодные индикаторы начнут мигать). Нажать любую кнопку, чтобы включить/выключить на ней подсветку. Для изменения приписанного цвета нажать **[FN]** + **[=+]**. Повторить выбор цвета для всех кнопок, которые требуется подсветить.
3. Нажать **[FN]** + **[~]**, чтобы сохранить пользовательский режим, светодиодные индикаторы перестанут мигать.

MULTIMEDIAKNAPPAR/PROGRAMTANGENTER

	+		= Dator
	+		= Webbläsare
	+		= Kalkylator
	+		= Musikspelare
	+		= Föregående låt
	+		= Nästa låt
	+		= Spela upp / Pausa
	+		= Stoppa
	+		= Ljudavstängning
	+		= Volym ned
	+		= Volym upp

HOTKEYS

	+		= Spelläge (låsnings av Windows-knappen)
	+		= Byta WASD-knappar och riktningknappar (pilar)

FABRIKSINSTÄLLNINGAR

	+		= Tryck på [FN] (ENDORFY-logoknapp) + [Esc] i 3 sekunder för att återställa användarinställningarna.
---	---	---	--

VOLYMRULLE

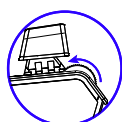

Volym ned





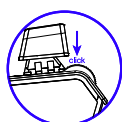







Volym upp















Ljudavstängning

LED-BELYSNING

	+			= Öka / minska ljusstyrka
	+			= Hastighet av belysningseffekter
	+			= Ändra effektens riktning
	+			= Ändra belysningsfärg

18 BELYSNINGSEFFEKTER

	+		= Lägen 1-3
	+		= Lägen 4-6
	+		= Lägen 7-9
	+		= Lägen 10-12
	+		= Lägen 13-15
	+		= Lägen 16-18





SKAPA ELLER MODIFIERA ETT ANVÄNDARLÄGE

- Tryck på **[FN]** (ENDORFY logoknapp) + **[·-]** för att gå in i användarlägen.
- När du är i användarläge, tryck på **[FN]** + **[·-]** igen för att gå in i redigeringsläge (LED-indikatorerna börjar blinka). Tryck på valfri knapp för att slå på/stänga av dess bakgrundsbelysning. För att ändra den tilldelade färgen, tryck på **[FN]** + **[=+]**. Upprepa färgvalet för alla knappar som ska vara bakgrundsbelysta.
- Tryck på **[FN]** + **[·-]** för att spara användarläget, LED-indikatorerna slutar blinka.

MULTIMEDIÁLNE/SOFTVÉROVÉ KLÁVESY

	+		= Počítač
	+		= Internetový prehliadač
	+		= Kalkulačka
	+		= Hudobný prehrávač
	+		= Predchádzajúca skladba
	+		= Ďalšia skladba
	+		= Prehrať/pozastaviť
	+		= Zastaviť
	+		= Stlmiť
	+		= Tichšie
	+		= Hlasnejšie

HOTKEYS

	+		= Herný režim (uzamknutie klávesov Windows)
	+		= Nahradiť WASD a smerové klávesy (šípky)

OBNOVIŤ TOVÁRENSKÉ NASTAVENIA

	+		= Stlačením [FN] (kláves s logom ENDORFY) + [Esc] na 3 sekundy obnovíte používateľské nastavenia.
---	---	---	---

KLIESKO - HLASITOSŤ

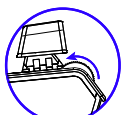

Tichšie





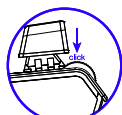







Hlasnejšie















Stlmiť

LED PODSVIETENIE

	+			= Zvýšenie /zniženie jasú
	+			= Rýchlosť efektov podsvietenia
	+			= Zmeniť smer efektu
	+			= Zmena farby podsvietenia

18 EFEKTOV PODSVIETENIA

	+		= Režimy 1-3
	+		= Režimy 4-6
	+		= Režimy 7-9
	+		= Režimy 10-12
	+		= Režimy 13-15
	+		= Režimy 16-18





VYTVORIŤ ALEBO UPRAVIŤ POUŽÍVATEĽSKÝ REŽIM

1. Stlačením **[FN]** (kláves s logom ENDORFY) + **[^-]** prejdete do režimov používateľa.
2. V používateľskom režime znova stlačte **[FN]** + **[^-]**, čím prejdete do režimu úprav (kontrolky LED začnú blikať). Stlačením ľubovoľného tlačidla zapnete/vypnete podsvietenie. Ak chcete zmeniť priradenú farbu, stlačte **[FN]** + **[=+]**. Zopakujte výber farby pre všetky tlačidlá, ktoré chcete posvietiť.
3. Stlačením **[FN]** + **[^-]** uložíte používateľský režim, kontrolky LED prestanú blikať.



МУЛЬТИМЕДІЙНІ/ПРОГРАМНІ КНОПКИ

	+		=	Комп'ютер
	+		=	Веб-браузер
	+		=	Калькулятор
	+		=	Музичний програвач
	+		=	Попередня пісня
	+		=	Наступна пісня
	+		=	Відтворення / Пауза
	+		=	Стоп
	+		=	Відключення звуку
	+		=	Зменшити гучність
	+		=	Збільшити гучність

HOTKEYS

	+		=	Ігровий режим (блокування клавіші Windows)
	+		=	Заміна WASD і клавіш управління курсором (стрілок)

СКИДАННЯ ДО ЗАВОДСЬКИХ НАЛАШТУВАНЬ





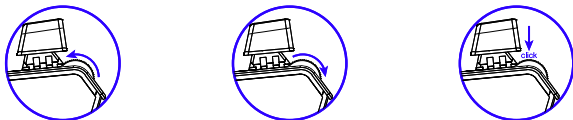





	+		=	Натиснути [FN] (клавіша з логотипом ENDORFY) + [Esc] і утримувати їх протягом 3 секунд, щоб скинути користувацькі налаштування.
---	---	---	---	---

РОЛИК РЕГУЛЮВАННЯ ГУЧНОСТІ















Зменшити гучність Збільшити гучність Відключення звуку

СВЕТОДИОДНА ПОДСВЕТКА

	+		+		=	Збільшення / зменшення яскравості
	+		+		=	Швидкість ефектів підсвічування
	+		=	Зміна напрямку ефекту		
	+		=	Зміна кольору підсвічування		

18 ЕФЕКТІВ ПІДСВІЧУВАННЯ

	+		=	Режими 1-3
	+		=	Режими 4-6
	+		=	Режими 7-9
	+		=	Режими 10-12
	+		=	Режими 13-15
	+		=	Режими 16-18

СТВОРЕННЯ АБО МОДИФІКАЦІЯ КОРИСТУВАЦЬКОГО РЕЖИМУ

1. Натиснути **[FN]** (клавіша з логотипом ENDORFY) + **[~]** для входу в режими користувача.
2. У режимі користувача ще раз натиснути **[FN]** + **[~]**, щоб увійти в режим редагування (світлодіодні індикатори почнуть блимати). Натиснути будь-яку кнопку, щоб увімкнути/вимкнути на ній підсвічування. Щоб змінити приписаний колір, потрібно натиснути **[FN]** + **[=+]**. Повторити операцію вибору кольору для всіх кнопок, які потрібно підсвітити.
3. Натиснути **[FN]** + **[~]**, щоб зберегти режим користувача, світлодіодні індикатори перестануть блимати.

EN Safety instruction

1. Use the product only as intended.
2. Make sure that the product is in good working order before using it.
3. This device is intended for indoor use, under normal humidity conditions. Do not use it outdoors.
4. Do not install and use the device within reach of children.
5. Before connecting the device, wait until it heats up to the ambient temperature to prevent damage due to condensation.
6. Only use a clean, dry cloth for cleaning. Do not touch the device with wet hands.
7. The device does not have any parts that can be repaired by the user. Return the device to the service centre for repair.
8. The warranty will be voided if you open the enclosure or modify the device.
9. The product should be used as intended. Incorrect use may damage the product and be dangerous to your health.
10. Do not use the product near liquids or in places where it may be directly exposed to liquids. If the device comes into contact with any liquids, immediately disconnect it from the power source.
11. The warranty does not cover mechanical damage to the product.
12. If the device malfunctions, promptly disconnect the power supply and contact the technical support department of Endorfy.
13. Do not discard electrical and electronic equipment together with other household waste.
14. The end user is obliged to remove unnecessary or faulty electrical equipment to the collection point or the seller. To obtain additional information, contact the local authorities or the store where you purchased the product.

DE Sicherheitshinweis

1. Das Produkt darf nur für den vorgesehenen Zweck verwendet werden.
2. Stellen Sie vor der Verwendung sicher, dass das Produkt nicht beschädigt ist.
3. Dieses Gerät ist für den Gebrauch in Innenräumen bei normaler Luftfeuchtigkeit bestimmt. Verwenden Sie es nicht im Freien.
4. Dieses Gerät darf nicht in Reichweite von Kindern installiert und verwendet werden.
5. Warten Sie vor dem Anschließen des Geräts, bis es sich auf Umgebungstemperatur erwärmt hat, um Schäden durch kondensierte Feuchtigkeit zu vermeiden.
6. Nur mit einem sauberen, trockenen Tuch reinigen. Berühren Sie das Gerät nicht mit nassen Händen.
7. Enthält keine Teile, die selbst repariert werden können. Senden Sie das Gerät zur Reparatur an das Service-Center.
8. Das Öffnen des Gehäuses sowie Veränderungen am Gerät führen zum Erlöschen der Garantie.
9. Das Produkt sollte bestimmungsgemäß verwendet werden. Eine unsachgemäße Verwendung kann das Produkt beschädigen und Gesundheitsgefahren für den Benutzer mit sich bringen.
10. Das Produkt darf nicht in der Nähe von Flüssigkeiten verwendet oder diesen direkt ausgesetzt werden. Trennen Sie das Produkt bei Kontakt mit Flüssigkeiten sofort von der Stromversorgung.
11. Die Garantie deckt keine mechanischen Schäden am Produkt ab.
12. Trennen Sie im Falle einer Fehlfunktion sofort die Stromquelle und wenden Sie sich an den technischen Support von Endorfy.
13. Elektrische und elektronische Geräte dürfen nicht mit dem anderen Hausmüll entsorgt werden.
14. Der Endverbraucher ist verpflichtet, nicht benötigte oder nicht funktionstüchtige Elektrogeräte bei einer Sammelstelle oder dem Händler abzugeben. Wenden Sie sich für weitere Informationen an Ihre örtlichen Behörden oder an das Geschäft, in dem Sie das Produkt gekauft haben.

ES Instrucciones de seguridad

1. El producto debe utilizarse única y exclusivamente conforme a su destino.
2. Antes de comenzar a usarlo es necesario comprobar que el producto no está dañado.
3. Este dispositivo está destinado para su uso en interiores, en condiciones normales de humedad del aire. No lo utilices en el exterior.
4. Este dispositivo no debe instalarse ni utilizarse al alcance de los niños.
5. Antes de conectar el dispositivo espera a que se caliente hasta la temperatura ambiente para evitar un daño debido a la humedad condensada.
6. Limpialo únicamente con un paño limpio y seco. No toques el dispositivo con las manos mojadas.
7. No contiene piezas que puedan ser reparadas por uno mismo. Devuelve el dispositivo al centro de servicio técnico para su reparación.
8. La apertura de la carcasa o la modificación del dispositivo anulan la garantía.
9. El producto deberá ser utilizado conforme a su destino. Un uso indebido puede provocar un daño del producto y suponer un riesgo para la salud del usuario.
10. El producto no debe utilizarse cerca de líquidos ni ser expuesto a su acción directa. En caso de contacto con líquidos se debe desconectar inmediatamente el producto de la alimentación.
11. La garantía no cubre los daños mecánicos del producto.
12. En caso de aparecer un funcionamiento incorrecto se debe desconectar inmediatamente la fuente de alimentación y contactar con el departamento de asistencia técnica de la empresa Endorfy.
13. Los aparatos eléctricos y electrónicos no deben desecharse junto con otros residuos domésticos.
14. El usuario final está obligado a llevar los aparatos eléctricos innecesarios o que no funcionan a un punto de recogida o de venta. Para conseguir información adicional contacta con las autoridades locales o la tienda en la que compraste el producto.

FR Consignes de sécurité

1. Le produit doit être utilisé uniquement aux fins pour lesquelles il a été conçu.
2. Avant de l'utiliser, assurez-vous que le produit n'est pas endommagé.
3. Cet appareil est destiné à une utilisation en intérieur, avec une humidité de l'air normale. Ne l'utilisez pas à l'extérieur.
4. Cet appareil ne doit pas être installé et utilisé dans un endroit à la portée des enfants.
5. Avant de brancher l'appareil, attendez qu'il atteigne la température ambiante pour éviter tout dommage dû à la condensation.
6. Nettoyez uniquement avec un chiffon propre et sec. Ne touchez pas l'appareil avec les mains mouillées.
7. L'appareil ne contient aucune pièce qui pourrait être réparée par l'utilisateur. Remenez l'appareil au centre de service pour réparation.
8. L'ouverture du boîtier ou la modification de l'appareil annule la garantie.
9. Le produit doit être utilisé conformément à l'usage auquel il est destiné. Une utilisation incorrecte peut endommager le produit et présenter un risque pour la santé de l'utilisateur.
10. Le produit ne doit pas être utilisé à proximité de liquides ou exposé au contact direct avec ceux-ci. En cas de contact avec des liquides, débranchez immédiatement le produit de l'alimentation électrique.
11. La garantie ne couvre pas les dommages mécaniques du produit.
12. En cas de dysfonctionnement, débranchez immédiatement la source d'alimentation et contactez le support technique d'Endorfy.
13. Les appareils électriques et électroniques ne doivent pas être jetés avec les autres déchets ménagers.
14. L'utilisateur final est tenu de rapporter les appareils électriques usés ou non fonctionnels à un point de collecte ou à un vendeur. Pour plus d'informations, contactez vos autorités locales ou le magasin où vous avez acheté le produit.

CZ Bezpečnostní pokyny

1. Výrobek používejte pouze k určenému účelu.
2. Před použitím se ujistěte, že výrobek není poškozený.
3. Toto zařízení je určeno pro použití v interiéru za normálních vlhkostních podmínek. Nepoužívejte ho venku.
4. Neinstalujte a nepoužívejte toto zařízení v dosahu dětí.
5. Před připojením zařízení počkejte, až se zahřeje na okolní teplotu, aby nedošlo k poškození způsobené kondenzovanou vlhkostí.
6. Čistěte pouze čistým suchým hadříkem. Nedotýkejte se zařízení mokrymi rukama.
7. Neobsahuje díly, které by mohl uživatel opravit. Vraťte zařízení do servisního střediska pro opravu.
8. Otevřením krytu nebo úpravou zařízení se ruší záruka.
9. Výrobek by měl být používán v souladu se svým určením. Nesprávné použití může způsobit poškození výrobku a způsobit nebezpečí pro zdraví uživatele.
10. Výrobek by se neměl používat v blízkosti kapalin nebo v jejich přímém kontaktu. V případě kontaktu s kapalinami okamžitě odpojte výrobek od napájení.
11. Záruka se nevztahuje na mechanické poškození výrobku.
12. Pokud dojde k poruše, okamžitě odpojte zdroj napájení a kontaktujte technickou podporu Endorfy.
13. Nevyhazujte elektrická a elektronická zařízení spolu s jiným domácím odpadem.
14. Koncový uživatel je povinen odvézt nepotřebné nebo nefunkční elektrické spotřebiče do sběrného místa nebo k prodejci. Další informace získáte na místním úřadě nebo v obchodě, kde jste výrobek zakoupili.

DK Sikkerhedsvejledning

1. Das Produkt darf nur für den vorgesehenen Zweck verwendet werden.
2. Stellen Sie vor der Verwendung sicher, dass das Produkt nicht beschädigt ist.
3. Dette udstyr er beregnet til indendørs brug under normale fugtighedsforhold. Brug den ikke udendørs.
4. Dette udstyr må ikke installeres eller bruges inden for børns rækkevidde.
5. Før du tilsætter udstyret, skal du vente, indtil det er blevet opvarmet til omgivelsestemperatur for at undgå skader på grund af kondenseret fugt.
6. Rengør kun med en ren, tør klud. Rør ikke ved udstyret med våde hænder.
7. Det indeholder ingen dele, som man selv kan reparere. Send udstyret tilbage til servicecentret for at få den repareret.
8. Åbning af huset eller ændring af udstyret medfører, at garantien bortfalder.
9. Produktet skal anvendes i overensstemmelse med dets anvendelsesformål. Ukorrekt brug kan beskadige produktet og medføre sundhedsrisici for brugeren.
10. Produktet skal holdes i nærheden af væsker, og udsæt det ikke direkte for væskernes påvirkning. I tilfælde af kontakt med væsker skal produktet straks afbrydes fra strømforsyningen.
11. Garantien omfatter ikke mekaniske beskadigelser af produktet.
12. I tilfælde af funktionfejlfald skal man straks afbryde strømkilden og kontakte teknisk supportafdeling fra Endorfy.
13. Elektrisk og elektronisk udstyr bør ikke bortskaffes sammen med andet husholdningsaffald.
14. Slutbrugeren er forpligtet til at aflevere uønsket eller ikke-fungerende elektrisk udstyr til et indsamlingssted eller til en forhandler. Du kan få flere oplysninger ved at kontakte lokale myndigheder eller den butik, hvor du har købt produktet.

FI Turvallisuusohjeet

1. Käytä tuotetta vain sille tarkoitettuun tarkoitukseen.
2. Varmista ennen käyttöä, että tuote ei ole vahingoittunut.
3. Tämä laite on tarkoitettu sisäkäyttöön normaaleissa kosteusolosuhteissa. Älä käytä sitä ulkona.
4. Tätä laitetta ei saa asentaa tai käyttää lasten ulottuvilla.
5. Anna laiteen lämmetä huoneilmpötilaan ennen sen kytkemistä kondensiveden aiheuttamien vaurioiden välttämiseksi.
6. Puhdista vain puhtaalla, kuivalla liinalla. Älä koske laitteeseen märillä käsillä.
7. Sisällä ei ole huollettavia osia. Palauta laite huoltokeskukseen korjattavaksi.
8. Koteloon avaaminen tai laiteen muuttaminen mitätöi takuun.
9. Tuotetta tulee käyttää sen käyttöohjeiden mukaisesti. Väärä käyttö voi vahingoittaa tuotetta ja aiheuttaa terveysriskin käyttäjälle.
10. Tuotetta ei saa käyttää nesteiden läheisyydessä eikä altistaa niiden suorille vaikutuksille. Jos tuote joutuu kosketuksiin nesteiden kanssa, irrota se välittömästi virtalähteestä.
11. Takuu ei kata tuotteen mekaanisia vaurioita.
12. Jos toimintahäiriö ilmenee, irrota virtalähde välittömästi ja ota yhteyttä Endorfy:n tekniseen tukeen.
13. Sähkö- ja elektroniikkalaitteita ei saa hävittää muun kotitalousjätteen mukana.
14. Lopputyöntekijä on velvollinen viemään tarpeettomat tai toimimattomat sähkölaitteet keräyspisteeseen tai myyjään. Jos haluat lisätietoja, ota yhteyttä paikallisiin viranomaisiin tai liikkeeseen, josta ostit tuotteen.

HU Biztonsági utasítás

1. A terméket csak és kizárólag rendeltetésszerűen szabad használni.
2. A használat megkezdése előtt meg kell bizonyosodni arról, hogy a termék nem sérült.
3. Ez a berendezés beltéri, normál levegő-páratartalmú viszonyok közti használatra készült. Ne használja kültérben.
4. Ezt a berendezést gyermekek hozzáférésetől távol kell beüzemelni és használni.
5. A berendezés csatlakoztatása előtt várja meg, amíg környezeti hőmérsékletre melegszik, ekerülendő a kicsapódott nedvesség miatti esetleges meghibásodást.
6. Kizárólag tiszta, száraz kendővel tisztítandó. A berendezést nedves kézzel megérinteni tilos.
7. Nem tartalmaz önállóan javítható alkatrészeket. Javítás érdekében adja le a berendezést egy szervizközpontba.
8. A borítás felnyitása vagy a berendezés módosítása érvényteleníti a jótállást.
9. A termék rendeltetésszerűen használható. A helytelen használat a termék károsodásához vezethet, és veszélyt jelenthet a felhasználó egészségére.
10. A terméket nem szabad folyadékok közelségében használni, sem folyadék közvetlen hatásának kitenni. Folyadékkal történő érintkezés esetén haladéktalanul le kell csatlakoztatni a terméket az energiaellátásról.
11. A jótállás nem terjed ki a termék mechanikus sérüléseire.
12. Hibás működés fellépése esetén haladéktalanul le kell csatlakoztatni a berendezést az energiaellátásról, és kapcsolatba kell lépni az Endorfy vállalat műszaki segítségnyújtásával.
13. Az elektromos és elektronikus készülékeket nem szabad más háztartási hulladékokkal együtt kidobni.
14. A végfelhasználó köteles a feleslegessé vált vagy nem működő elektromos berendezéseket egy gyűjtőpontra vagy az eladóhoz eljuttatni. További tájékoztatás érdekében lépjen kapcsolatba a helyi hatóságokkal, vagy az üzlettel, ahol a terméket megvásárolta.

IT Manuale di sicurezza

- Il prodotto deve essere utilizzato esclusivamente per la destinazione d'uso prevista.
- Prima di iniziare l'utilizzo, assicurarsi che il prodotto non sia danneggiato.
- Questo dispositivo è progettato per l'uso all'interno di locali, in condizioni di normale umidità dell'aria. Non utilizzare il prodotto all'esterno.
- Non installare o utilizzare questo dispositivo alla portata dei bambini.
- Prima di collegare il dispositivo, attendere che si riscaldi a temperatura ambiente per evitare danni dovuti all'umidità condensatasi.
- Pulire solo con un panno pulito e asciutto. Non toccare il dispositivo con le mani bagnate.
- Il dispositivo non contiene parti che possono essere riparate autonomamente. Affidare il dispositivo ad un centro di assistenza per la riparazione.
- L'apertura della custodia o la modifica del dispositivo comportano il decadimento della garanzia.
- Il prodotto deve essere utilizzato solo conformemente alla sua destinazione d'uso. Non toccare il dispositivo con le mani bagnate e rappresentare un rischio per la salute dell'utente.
- Il prodotto non deve essere utilizzato vicino a liquidi o esposto direttamente ad essi. In caso di contatto con liquidi, il prodotto deve essere immediatamente scollegato dall'alimentazione.
- La garanzia non copre i danni meccanici al prodotto.
- In caso di malfunzionamento, scollegare immediatamente la sorgente di alimentazione e contattare il supporto tecnico dell'azienda Endorfy.
- I dispositivi elettrici ed elettronici non devono essere smaltiti insieme ad altri rifiuti domestici.
- Utente finale è tenuto a consegnare le apparecchiature elettroniche non necessarie o non funzionanti al punto di raccolta o al rivenditore. Per ulteriori informazioni, contattare l'autorità locale competente o il negozio in cui è stato acquistato il prodotto.

PL Instrukcja bezpieczeństwa

- Produkt należy używać tylko i wyłącznie z jego przeznaczeniem.
- Przed rozpoczęciem użytkowania należy upewnić się, że produkt nie jest uszkodzony.
- To urządzenie jest przeznaczone do użytkowania w pomieszczeniach, w warunkach normalnej wilgotności powietrza. Nie używaj go na zewnątrz.
- Tego urządzenia nie należy instalować i używać w zasięgu dzieci.
- Zanim podłączysz urządzenie, odczekaj aż ogrzeje się do temperatury otoczenia, aby zapobiec uszkodzeniu z powodu skroplonej wilgoci.
- Czyść wyłącznie czystą, suchą szmatką. Nie dotykaj urządzenia mokrymi dłońmi.
- Nie zawiera części, które można samodzielnie naprawić. Zwróć urządzenie do centrum serwisowego do naprawy.
- Otwarcie obudowy lub modyfikacja urządzenia uniemożliwiają gwarancję.
- Produkt powinien być używany zgodnie z jego przeznaczeniem. Nieprawidłowe użytkowanie może spowodować uszkodzenie produktu oraz stworzyć zagrożenie dla zdrowia użytkownika.
- Produktu nie należy używać w pobliżu płynów ani narażać na ich bezpośrednie działanie. W przypadku kontaktu z płynami należy niezwłocznie odłączyć produkt od zasilania.
- Gwarancja nie obejmuje uszkodzeń mechanicznych produktu.
- W przypadku wystąpienia nieprawidłowego działania należy niezwłocznie odłączyć źródło zasilania oraz skontaktować się z działem pomocy technicznej firmy Endorfy.
- Urządzeń elektrycznych i elektronicznych nie należy wyrzucać wraz z innymi odpadami domowymi.
- Użytkownik końcowy zobowiązany jest oddać niepotrzebne lub niedziałające urządzenia elektryczne do punktu zbiórki lub sprzedawcy. W celu uzyskania dodatkowych informacji skontaktuj się z władzami lokalnymi lub sklepem w którym kupiłeś produkt.

RU Инструкция з безпеки

- Продукт необходимо использовать только по назначению.
- Перед началом использования следует убедиться, что продукт не поврежден.
- Это устройство предназначено для использования в помещении при нормальной влажности воздуха. Не использовать на открытом воздухе.
- Это устройство не следует устанавливать и использовать в доступном для детей месте.
- Перед подключением устройства необходимо подождать, пока оно не нагреется до температуры окружающей среды, чтобы предотвратить повреждение из-за образования на нем конденсата.
- Чистить только сухой и чистой тканью. Не прикасаться к устройству мокрыми руками.
- Не содержит элементов, которые можно самостоятельно отремонтировать. Устройство следует сдать в сервисный центр для ремонта.
- Открытие корпуса или модификация устройства приведет к аннулированию гарантии.
- Продукт необходимо использовать по назначению. Неправильное использование может привести к повреждению устройства и создать опасность для здоровья пользователя.
- Продукт не следует использовать рядом с жидкостями или подвергать их непосредственному воздействию. В случае контакта с жидкостями необходимо немедленно отключить устройство от источника питания.
- Гарантия также не распространяется на механические повреждения продукта.
- В случае неисправности необходимо немедленно отключить источник питания и обратиться в службу технической поддержки Endorfy.
- Электрические и электронные устройства нельзя утилизировать вместе с другими бытовыми отходами.
- Конечный пользователь обязан сдать ненужные или неработающие электронные приборы в пункт приема или продавца. Для получения дополнительной информации следует обратиться в местные органы власти или в магазин, где было приобретено устройство.

SK Bezpečnostné pokyny

- Výrobok používať len na určený účel.
- Pred použitím sa uistite, že výrobok nie je poškodený.
- Toto zariadenie je určené na používanie v interiéri za normálnych vlhkosťných podmienok. Nepoužívajte ho v exteriéri.
- Toto zariadenie by sa nemalo inštalovať ani používať v dosahu detí.
- Pred pripojením zariadenia počkajte, kým sa zahreje na teplotu okolia, aby ste zabránili jeho poškodeniu v dôsledku kondenzovanej vlhkosti.
- Čistite len čistou, suchou handričkou. Nedotýkajte sa zariadenia mokrymi rukami.
- Neobsahuje diely, ktoré môže používateľ samostatne opraviť. Vráťte zariadenie do servisného strediska na opravu.
- Otvorením krytu alebo úpravou zariadenia pridete o záruku.
- Výrobok by sa mal používať na určený účel. Nesprávne používanie môže spôsobiť poškodenie výrobku a ohrozenie zdravia používateľa.
- Výrobok by sa nemal používať v blízkosti kvapalín alebo v ich priamom kontakte. V prípade kontaktu s kvapalinami okamžite odpojte výrobok od napájania.
- Záruka sa nevzťahuje na mechanické poškodenie výrobku.
- Ak sa vyskytne porucha, okamžite odpojte zdroj napájania a kontaktujte technickú podporu spoločnosti Endorfy.
- Elektrické a elektronické zariadenia by sa nemali likvidovať spolu s ostatným domovým odpadom.
- Konečný spotrebiteľ má povinnosť odovzdať nepotrebné alebo nefunkčné elektrozariadenia na zberné miesto alebo predajcovi. Ďalšie informácie získate na miestnom úrade alebo v obchode, kde ste výrobok zakúpili.

NO Sikkerhetsinstruks

- Produktet skal kun brukes til det tiltenkte formålet.
- Før du bruker produktet, forsikre deg om at det ikke er skadet.
- Denne enheten er beregnet for innendørs bruk, ved normal luftfuktighet. Ikke bruk den utendørs.
- Denne enheten bør ikke installeres og brukes innenfor rekkevidde for barn.
- Før du kobler til enheten, vent til den har varmet opp til omgivelsestemperatur for å unngå skade på grunn av kondens.
- Rengjøres kun med en ren, torr klut. Ikke berør enheten med våte hender.
- Enheten inneholder ingen komponenter som kan repareres på egen hånd. Returner enheten til servicesenteret for reparasjon.
- Åpning av huset eller endring i enheten vil gjøre garantien ugyldig.
- Produktet bør brukes i samsvar med tiltenkt bruk. Feil bruk kan føre til skade på produktet og en helseisiko for brukeren. Produktet skal ikke brukes i nærheten av væsker eller utsettes for direkte innvirkning av væsker. Tilfelle kontakt med væsker, koble produktet fra strømforsyningen umiddelbart.
- Garantien dekker ikke mekaniske skader på produktet.
- Tilfelle feil, koble fra strømforsyningen umiddelbart og kontakt teknisk støtte hos Endorfy.
- Elektrisk og elektronisk utstyr skal ikke kastes sammen med annet husholdningsavfall.
- Sluttbruker plikter å levere elektrisk utstyr som ikke virker eller ikke er brukt lenger til et innsamlingssted eller til selgeren. For mer informasjon, kontakt lokale myndigheter eller butikken der du kjøpte produktet.

RO Instrucțiuni de siguranță

- Utilizati produsul numai in scopul pentru care a fost conceput.
- Înainte de utilizare, asigurați-vă că produsul nu este deteriorat.
- Acest dispozitiv este destinat utilizării în interiorul încăperilor și în condiții normale de umiditate a aerului. Nu folosiți dispozitivul în exterior.
- Acest dispozitiv nu trebuie instalat sau utilizat în locații în care sunt prezenți copii.
- Înainte de a conecta dispozitivul, așteptați până când acesta se încălzește la temperatura ambiantă, pentru a preveni deteriorarea din cauza umidității condensate.
- Curățați dispozitivul numai cu o cârpă curată și uscată. Nu atingeți dispozitivul cu mâinile umeze.
- Acesta nu conține elemente care a putea fi reparate de către dumneavoastră. Returnați dispozitivul la centrul de service pentru efectuarea de reparații.
- Deschiderea carcasei sau modificarea dispozitivului va avea ca efect anularea garanției.
- Produsul trebuie să fie utilizat în conformitate cu destinația sa. Utilizarea necorespunzătoare poate deteriora produsul și poate crea riscuri pentru sănătatea utilizatorului.
- Nu utilizați produsul în apropierea lichidelor și nu îl expuneți la contactul direct cu acestea. În cazul intrării în contact cu lichide, deconectați imediat produsul de la sursa de alimentare.
- Garanția nu acoperă avarierile mecanice ale produsului.
- Dacă se observă o defecțiune, deconectați imediat sursa de alimentare și contactați asistența tehnică a companiei Endorfy.
- Echipamentele electrice și electronice nu trebuie eliminate împreună cu alte deșeurii menajere.
- Utilizatorul final este obligat să furnizeze echipamentele electrice nedorite sau nefuncționale la un punct de colectare sau la vânzător. Pentru a primi mai multe informații, contactați autoritățile locale sau magazinul de unde ați cumpărat produsul.

SE Säkerhetsanvisningar

- Produkten får endast användas för det avsedda ändamålet.
- Kontrollera att produkten inte är skadad innan du använder den.
- Denna anordning är avsedd för inomhusbruk vid normal luftfuktighet. Använd den inte utomhus.
- Denna anordning får inte installeras och användas inom räckhåll för barn.
- Innan du ansluter anordningen, vänta tills dess temperatur har kommit upp i omgivningstemperaturen för att förhindra fuktskador på grund av kondens.
- Rengör endast med en ren, torr trasa. Rör inte vid anordningen med våta händer.
- Produkten innehåller inga delar som du kan reparera på egen hand. Lämnna in anordningen till servicecenter för reparation.
- Om du öppnar hölet eller modifierar anordningen blir garantin ogiltig.
- Produkten ska användas i enlighet med dess avsedda ändamål. Felaktig användning kan leda till skador på produkten och skapa en hälsorisk för användaren.
- Produkten får inte användas nära vätskor eller utsättas för direkt kontakt med dem. Vid kontakt med vätskor ska du koppla bort produkten från strömkällan omedelbart.
- Garantin täcker inte mekaniska skador på produkten.
- Vid felfunktion ska du koppla bort strömkällan omedelbart och kontakta Endorfy's tekniska support.
- Elektrisk och elektronisk utrustning ska inte slängas tillsammans med annat hushållsavfall.
- Slut användaren är skyldig att lämna in elektrisk utrustning som är onödigt eller fungerar till ett insamlingsställe eller återförsäljare. Kontakta dina lokala myndigheter eller butiken där du köpte produkten för mer information.

UA Інструкція з безпеки

- Продукт можна використовувати лише за призначенням.
- Перед початком використання слід переконатися, що продукт не пошкоджений.
- Цей пристрій призначений для використання у приміщенні за умов нормальної вологості повітря. Не використовувати на свіжому повітрі.
- Цей пристрій не слід встановлювати та використовувати у доступному для дітей місці.
- Перед підключенням пристрою необхідно почекати, поки він не нагріється до температури навколишнього середовища, щоб запобігти пошкодженню через утворення на ньому конденсату.
- Чистити тільки сухою та чистою тканиною. Не торкатися пристрою мокими руками.
- Не містити елементів, які можна самостійно відремонтувати. Для ремонту пристрій потрібно здати у сервісний центр.
- Відкриття корпусу або модифікація пристрою призведе до анулювання гарантії.
- Перед слід використовувати тільки за призначенням. Неправильне використання може привести до пошкодження пристрою та небезпек для здоров'я користувача.
- Продукт не слід використовувати поруч із рідинами або допускати потрапляння рідин на продукт. У разі контакту з рідиною необхідно негайно відключити пристрій від джерела живлення.
- Гарантія не поширюється на механічні пошкодження продукту.
- У разі несправності необхідно негайно відключити джерело живлення та звернутися до служби технічної підтримки Endorfy.
- Електричні та електронні пристрої не можна утилізувати разом з іншими побутовими відходами.
- Кінцевий користувач зобов'язаний здати непотрібні або неробочі електроприлади в пункт прийому або продавця. Для отримання додаткової інформації слід звернутися до місцевих органів влади або у магазин, де було придбано пристрій.