

Circular saw

Item No.: 28230

Model No.: M1Y-DU32-185R



Manual for use



Please read this manual carefully before using.

1. Technical specifications

Item No.	28230
Model No.	M1Y-DU32-185R
Rated voltage	230 V, 50 Hz
Capacity	1400 W
Protection class	II
No-load speed	4500 min ⁻¹
Adjustable inclination angle of cut	0-45°
Diameter of the disc	185 mm
Disc body thickness	1,3 mm±5 %
Cutting width	2,3 mm±5 %
Disc hole diameter after clamping	20 mm
Number of disc teeth	24 T
Cut ¹⁾ : at an inclination angle of 90° at an inclination angle of 45°	63 mm 42 mm
Dimension of the base plate	15 cm x 30,2 cm
Sound power level L _{WA}	L _{WA} : 110 dB(A); K _{WA} :3 dB(A)
Sound pressure level L _{PA}	L _{PA} :99 dB(A); K _{PA} :3 dB(A)
Work mode - vibration emission value	a _h :3,1m/s ² ; Uncertainty K:1,5m/s ²
Weight	4,3 kg

¹⁾The specified cut (maximum cutting depth) is achieved using a saw blade with a diameter specified in the technical data.

The declared overall value of vibrations and declared value of noise emissions were measured in accordance with a standardized testing method and can be used for comparing one tool with another. The declared overall value of vibrations and declared value of noise emissions can also be used for a preliminary assessment of exposure.

Warning:

The vibration and noise emissions during actual use of the tool may differ from the declared values depending on the way the tool is used, especially the type of workpiece being processed.

It is necessary to determine safety measures to protect the operator, which are based on an assessment of exposure under real conditions of use (taking into account all parts of the working cycle, such as the time the tool is switched off and running idle, in addition to the start-up time).

2. Components and controls



Fig. 1



1. Front handle
2. Motor ventilation slots (Motor rear cover)
3. Clamping screw for longitudinal cut stop (side guide)
4. Nut for adjusting the angle of inclination of the oblique cut
5. Spindle lock button for changing the saw blade
6. Base plate
7. Notch for placing the line of oblique cut
8. Notch for placing the line of perpendicular cut
9. Longitudinal cut stop (side guide)
10. Lower swing saw blade cover
11. Clamping screw of saw blade
12. Saw blade
13. Lever for swing the lower saw blade cover
14. Power cord
15. Dust outlet
16. Top protective cover of saw blade
17. On/Off switch
18. Main handle
19. Lock-off button
20. Depth adjustment lever
21. Cutting Depth scale

3. Before putting into operation

Notice: Before use, read the entire user manual and keep it attached to the product so that the operator can familiarize themselves with it. If you lend or sell the product to anyone, attach this manual to it.

3.1 Installation/replacement of saw blade

Warning: Installation or service operations performed on the circular saw must be done with the power supply disconnected.

Safety warnings for the saw blade

- Wear suitable protective gloves when handling the saw blade, as the user may be injured by the sharp teeth of the blade.
- Only install a saw blade on the saw that is marked with a speed equal to or higher than the speed marked on the tool.
- Only use saw blades in accordance with the markings on the saw model.
- Determine the correct saw blade to use for the material to be cut.

- Saw blades intended for cutting wood and similar materials must comply with EN 847-1.
- Do not install any abrasive blades on the saw.
- Use only sharp saw blades that are in good condition. If the blade is dull, it causes the saw blade tips to overheat. Damaged blades must not be repaired
- Use only the correct attachments (flanges, bolts, washers, etc.) for the saw blade model. Do not use any clamping sleeves for clamping saw blades with a larger diameter blade clamping hole.

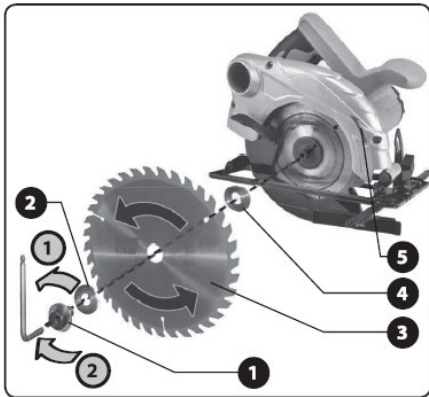

1.

Fig. 2

1. Place the saw on a flat surface with ventilation openings of the motor (Fig 1, position 2) facing downwards towards the surface.
2. Lock the spindle from rotating by pressing the lock button (Fig 1, position 5) .

Warning: Lock the saw spindle with the lock button only when the device is turned off and the spindle is not rotating. Locking the spindle while the saw is running can cause injury to the operator and damage to the saw.

3. Hold down the lock button and simultaneously unscrew the clamping screw (Fig 2, position 1) in the direction of arrow "1" (Fig 2) using a hex (Allen) according to the saw model.
4. Swing the lower saw blade cover (Fig 1, position 10) to one side and place the saw blade on the lower washer (Fig 2, position 4) so that the direction of the blade teeth matches the direction of the arrow on the upper saw blade cover(Fig 2, position 5).
5. Then hold down the lock button and simultaneously secure the saw blade by carefully tightening the clamping screw in the direction of arrow "2"(Fig 2).

3.2 Cutting depth setting

1. Unlock the lever (Fig 1, position 20) to release the body of the saw for movement in the vertical plane.
2. Lift the saw from the base plate to the required cutting depth. The cutting depth can be read on the cutting depth scale (Fig 1, position 21). A greater distance between the body of the saw and the base plate means a shallower cutting depth.

3. Then fix the saw at the set height again by using the lever (Fig 1, position 20).

3.3 Setting the angle of inclination for oblique cut

If necessary, adjust the inclination angle of the saw blade within the range of 0° to 45° relative to the base plate by loosening the nut (Fig 1, position 4) and tilting the body of the saw to the required angle of inclination, then re-tighten it with the same nut.

Notice

Oblique cutting have a shallower cutting depth than the set value on the cutting depth scale.

3.4 Connecting external sawdust extraction

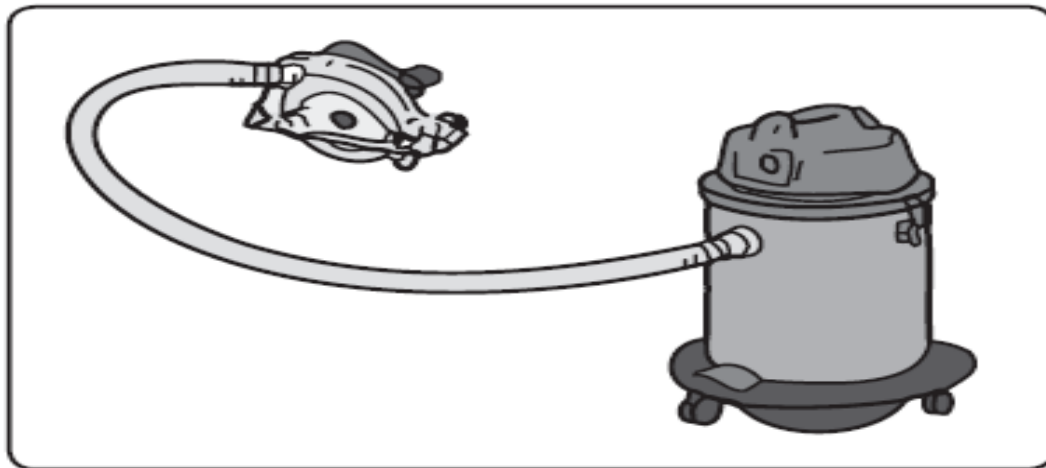

Fig. 3

Insert the hose end of a suitable industrial vacuum cleaner into the dust outlet (Fig 1, position 15) - if possible, connect it with a suitable hose adapter.

Notice

Use an industrial vacuum cleaner with sufficient filtration efficiency that is suitable for the type of the material being cut. Do not use a household vacuum cleaner as it may be damaged.

Warning

Cutting produces dust that is harmful to health when inhaled, especially dust from chemically treated materials. Therefore, when working with the saw, use dust extraction/collection and certified respiratory protection with an adequate protection level. Consult a store for personal protective equipment. Ensure good ventilation of the area during operation. Dust from hard wood is considered carcinogenic.

3.5 Installing the longitudinal cut stop (side guide)

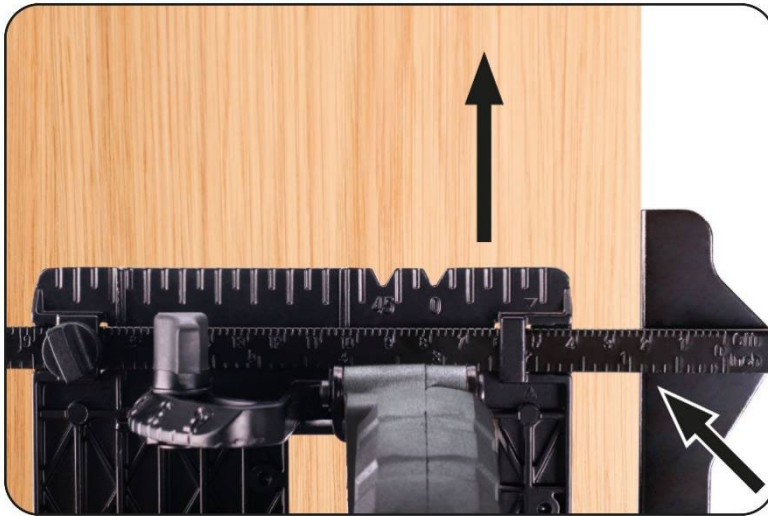

Fig. 4

The longitudinal cut stop (Fig 1, position 9) allows for precise guidance of the cut along the edge of the processed material and also prevents the saw blade from bending during cutting.

It is also used for cutting parts of the same size.

1. Loosen the clamping screw (Fig 1, position 3) for longitudinal cutting to fix the longitudinal cut stop, and place the part of the longitudinal stop with the scale in the base plate see Fig 1.
2. Set the required width of the workpiece to be cut on the longitudinal stop scale and then secure the longitudinal cut stop by tightening the clamping screw.

4. Preparation of materials to be cut

1. Fix the material to be cut with a suitable clamping device, e.g. clamping clamps to the work surface before cutting (Fig. 5).

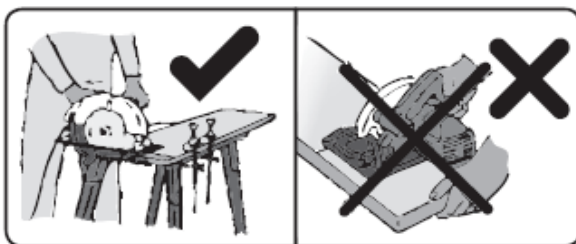

Fig. 5

Support large areas of the edges and near the cutting point to reduce the risk of saw blade clamping and kickback due to board deflection (Fig. 6)

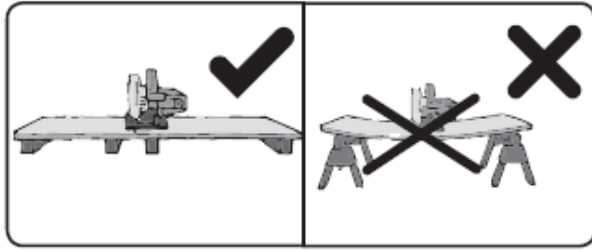

Fig. 6

2. Draw a cut line on the material to be cut.

5. Switching on/off and working with the saw

Warning

Before connecting the saw to the power source, make sure that all securing elements are properly in place and check if all protective components and parts are in their proper place and properly secured. The lower protective cover must cover almost the entire saw blade. Make sure that the lower protective cover can be completely opened by hand and automatically returns to its initial position. Do not use the saw without all protective components or with poorly secured parts and ensure proper repair.

Warning

Before connecting the saw to the power source, make sure that the voltage value in the socket corresponds to the range of 220-240 V, 50 Hz.

Notice

To verify the setting parameters of the saw, we recommend to perform a test cut at first.

1. Insert the plug of the power cord into the power outlet.
2. Firmly grip the saw with both hands on the main and front handle (see Fig 7) and place the front part of the base plate on the cutting surface so that the blade does not touch the material being cut and can rotate freely. Never hold the saw with one hand.
3. To start the saw, first press the lock-off button (Fig 1, position 19) and then press the On/Off switch (Fig 1, position 17).

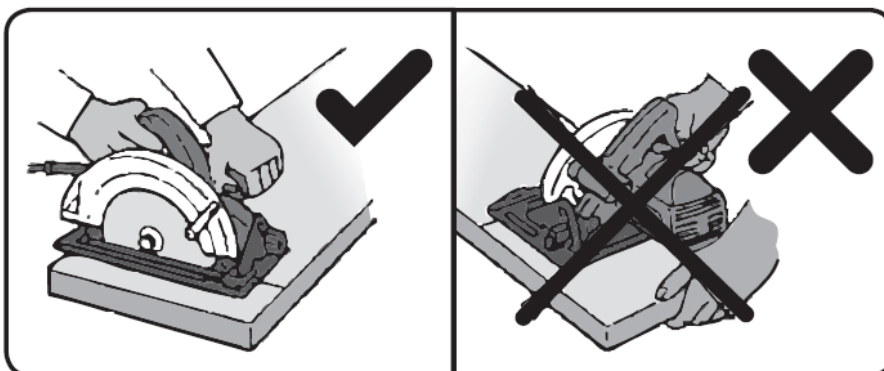

Fig. 7

Notice

If any abnormal noise, vibration or operation is noticeable during the operation of the device, immediately turn off the device, disconnect it from the power supply, then determine and repair the cause of the abnormal operation. If the abnormal operation is caused by a malfunction inside the device, have it repaired at an authorized service center.

4. Let the saw reach full speed, then slowly move it towards the marked cutting line with a notch marked 0° on the base plate for a vertical cut and a notch marked 45° for an oblique cut (see Fig 8A and 8B).

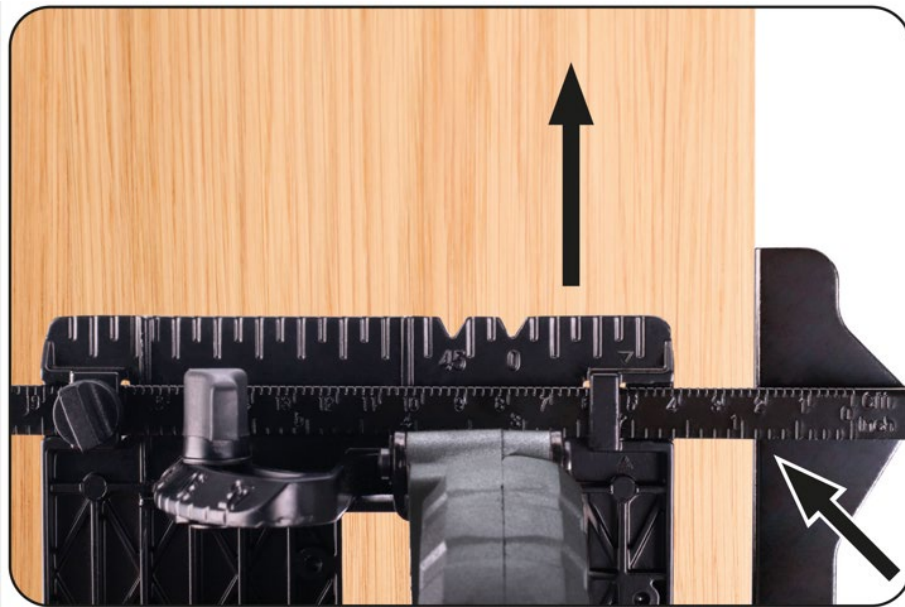

Fig. 8A

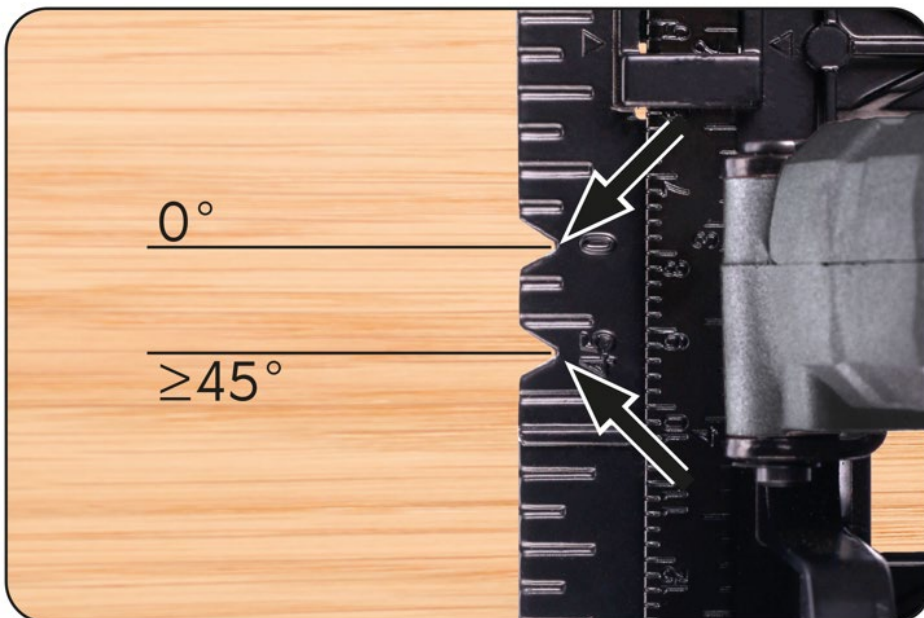



Fig. 8B

5. Move the saw slowly on the material surface until the whole cutting is completed.

Notice

- In the cutting process, run the saw towards the cutting line with equal movement and speed and light pressure. Excessive pressure on the saw leads to rapid wear of the saw blade, overheating of the saw blade tips, deterioration of cutting quality and overload of the saw blade, which can lead to damage of the saw.
- The cutting speed and cutting quality depends on the condition and shape of the saw teeth, so only use saw blades that are in perfect condition, have sharp teeth and are suitable for the respective material and cutting type.
- Choose the saw blade type according to the processed material. The supplied saw blade is only used for sawing wood. For cutting non-ferrous metals (e.g. aluminum, copper), a different saw blade must be chosen. Other types of metal (e.g. ferrous metals) are not allowed to be processed with this saw!
- Protect the saw blade from damage (e.g. collision, drop) so that it does not twist, etc.
- Do not put your fingers in the dust outlet. They could be injured by flying sawdust.
- Never install the mini circular saw in tables or other constructions. The saw is only used as a hand-driven device.
- Never use the saw to cut over the head. In this position, there is not enough stability to ensure safe working.
- Do not use HSS saw blades to cut. These saw blades are fragile and may break when cutting.
- During operation, the device generate an electromagnetic field which may have a negative impact on the function of active or passive medical implants (pacemakers) and endanger the life of the user. Before using this device, check with your doctor or implant manufacturer whether you are allowed to work with this device. 
- Use the saw only for its intended purpose. The saw should not be modified or converted for other purposes.

Turning off the saw

Turn off the saw by release the On/Off switch.

6. Cleaning and Maintenance

Warning

- Perform service and maintenance tasks with the power cord disconnected.
- After completing work, clean the saw of sawdust and debris. Use a brush, cloth, or compressed air to do this.
- It is essential to keep the motor's ventilation slots clean (see Fig 1, position 2) to prevent the motor from overheating due to insufficient airflow. Additionally, keep the space for the movement of the lower swing cover of the saw blade clean (see Fig 1, position 10) so that it

can move freely and return automatically after tilting. The automatic return of the lower cover is essential for safety reason.

- Also clean the saw blade and treat it with oil against corrosion if necessary. Clean the oil on the saw blade before use so that the cut wood is not contaminated if necessary.
- If necessary, have the saw blade professionally ground.
- A damaged saw blade should not be repaired, but be replaced with a good saw blade.

Notice

Do not clean the saw with organic solvents (such as acetone) as it may damage the plastic parts. Use a cloth soaked in a soap solution for cleaning. Prevent any water from entering the internal parts of the saw.

Checking/replacing carbon brushes

If sparking or irregular operation is observed during use, have the carbon brushes checked by a service technician.

For repairing the device, original manufacturer parts must be used.

7. General safety instructions

Warning

It is essential to read all safety instructions, instructions for use, pictures and regulations supplied with this tool. Failure to follow these instructions may result in electric shock, fires or serious personal injury.

All instructions must be kept so that you can re-check it later if necessary.

7.1 SAFETY OF THE WORKING ENVIRONMENT

- a) The workplace must be kept clean and well lit.** Clutter and dark areas are a cause of accidents.
- b) Power tools must not be used in explosive environment where flammable liquids, gases or dust are present.** Power tools produce sparks that can ignite dust or fumes.
- c) When using power tools, children and other persons must be prevented from entering.** If the operator is disturbed, he/she may lose control of the power tools.

7.2 ELECTRICAL SAFETY

- a) The power cord plug of the power tool must match with the power socket. The plug must never be modified in any way. Don't use socket adapters with tools that have a protective connection to earth.** Proper sockets will reduce the risk of electric shock.
- b) The operator must not touch grounded objects such as pipes, central heating units, stoves and refrigerators with his body.** The danger of electric shock is greater if your body is connected to ground.

- c) **Power tools should not be exposed to rain, moisture or wetness.** If water enters the power tool, the risk of electric shock increases.
- d) **The power cord should not be used for other purposes. Power tools should not be carried or pulled by the cord, the cord should not be pulled to disconnect the plug from the socket. The cord must be protected from heat, grease, sharp edges or moving parts.** Damaged or tangled cords increase the risk of electric shock.
- e) **When power tools are used outdoors, must use an extension cord suitable for outdoor use.** This reduces the risk of electric shock.
- f) **If the power tool is used in a wet environment, a power supply protected by a residual current device (RCD) must be used.** This reduces the risk of electric shock. The term RCD may be replaced by the terms: main circuit breaker (GFCI) or leakage circuit breaker (ELCB).

7.3 PERSONAL SAFETY

- a) **When using power tools, the operator must be attentive to what he is doing and must concentrate and think soberly. Power tools should not be used when the operator is tired or under the influence of drugs, alcohol or medication.** A moment's inattention when using power tools can cause injury. Tools can lead to serious personal injury.
- b) **Wear personal protective equipment. Always use eye protection.** Protective equipment such as respirator, safety shoes with non-slip finish, hard headgear or ear protection.
- c) **Unintentional starting of the machine must be avoided. Ensure that the switch is in the off position before plugging the plug into the socket or moving the tool.** Carrying tools with your finger on the switch or plugging the tool into socket with the switch on can cause accidents.
- d) **All adjustment tools or wrenches must be removed before the tool switch is on.** Adjustment tools or wrenches which leave to the rotating part of the tool may cause personal injury.
- e) **The operator should work in a safe place. The operator must maintain a stable posture and balance at all times.** This will allow better control of the power tool in unpredictable situations.
- f) **Dress appropriately. Do not wear loose clothing or jewellery.** Loose clothing, jewelry, or loose long hair can be caught by moving parts.
- g) **Where dust extraction and collection equipment is provided, it should be ensured that such equipment is connected and used correctly.** The use of such equipment can reduce the hazards caused by the dust generated.
- h) **The operators should not make themselves complacent due to the routine of frequent use of the tool and ignore the safety principles of the tool.** A minor action can cause serious injury in a split second.

7.4 USE AND MAINTENANCE OF POWER TOOLS

- a) **Power tools must not be overloaded. Tools must be used for the work for which they are intended.**
- b) **Do not use power tools that cannot be on and off by a switch.** If the switch does not work, the tool must be repaired.
- c) **The equipment must be unplugged from the power socket before any adjustment, replacement or storage.** This will prevent accidental starting of the power tool.
- d) **Unused power tools must be stored out of reach of children and persons who have not been familiar with the power tools and instructions.** Power tools are dangerous in the hands of inexperienced persons.
- e) **Power tools must be maintained and inspected. If a tool is damaged it must be repaired before it is used again.** Many accidents are caused by unmaintained power tools.
- f) **Cutting tools must be kept clean and sharp.**
- g) **Power tools must be used in accordance with the instructions.** Improper use of tools can lead to dangerous situations.
- h) **Handle and grip surfaces must be kept dry, clean and free of grease.** A dirty surface will not allow safe holding and control of the tool in unexpected situations.

7.5 SERVICE

- a) Repairs of power tools must be entrusted to qualified persons.

8. Supplement safety instructions

WHEN CUTTING

- a) **DANGER: The operator must ensure that his hands are at a safe distance from the cutting area and the saw blade. The other hand must be used to grip the additional handle or the motor housing.** If the saw is held with both hands, the hands cannot be cut by the saw blade.
- b) **Do not reach under the workpiece.** The protective cover cannot protect the operator from touching the blade in front of the workpiece.
- c) **Never hold the workpiece in the hand or over the knee while cutting. The workpiece must be clamped on a solid base.** It is important that the workpiece is properly supported and the risk of touching a body part, jamming the blade or losing control is minimized.
- d) **When performing work where the cutting tool may contact concealed wire or its own power cord, the power tool should be held with insulated gripping surfaces.** Contact with a "live" conductor will cause uninsulated metal parts of the power tool to also become "live" and may result in electric shock to the user.

- e) **A straight-edged ruler or guide must be used when making longitudinal cutting.** This improves cutting accuracy and reduces the risk of blade jamming.
- f) **Always use a saw blade with the correct clamping hole size and shape (diamond or circular).** Unfixed saw blades can cause loss of control.
- g) **Never use damaged or incorrect washers or screws to clamp the saw blade.** The blade clamping washers and screws have been designed specifically for your saw for optimum performance and safety.

8.1 ADDITIONAL SAFETY INSTRUCTIONS FOR ALL AGES

CAUSES OF RETURN AND RELATED WARNINGS

- Back-rotation is the sudden reaction of a clamped, blocked or misaligned saw blade, with the result that the saw blade moves uncontrollably upwards and away from the workpiece towards the operator;
- When the saw blade is clamped or completely blocked during sawing, the saw blade stops and the reaction force of the motor causes the saw blade to be rapidly ejected back towards the operator;
- If the saw blade is twisted or misaligned in the cut, the teeth on the back edge of the blade may strike the surface of the wood from above, the blade will jump out of the cut with the saw being ejected back towards the operator.

Side effects results from improper use of the saw or improper operating procedures or conditions and can be prevented by properly observing the following precautions.

- a) **The saw must be held with both hands and the arms must be in such a position as to resist the back-rotation forces. The operator's body must be on either side of the blade but not in the working line of the blade.** Back-rotation can cause the saw to be thrown backwards, but if appropriate safety precautions are taken, the forces caused by back-rotation can be handled by the user.
- b) **If the saw blade becomes jammed or if the cut needs to be interrupted for any reason, the switch control must be released and the saw held in place in the material until the saw blade comes to a complete stop. The operator must never attempt to lift the saw out of the cut or pull it back when the saw blade is in motion; in such cases, kickback may occur.** It is necessary to look for the causes of saw blade jamming and ways to eliminate these causes.
- c) **If the saw is started in the workpiece, the saw blade should be aligned so that the saw teeth are not embedded in the material.** If the saw blade becomes jammed, the saw may be pushed upward out of the workpiece or back-rotation may occur when the saw blade is started again.
- d) **Large workpieces must be supported to minimize the risk of rebound and saw blade clamping.** Large workpieces tends to bend under its own weight. There must be shims under the board on both sides near the cut and near the edges.
- e) **Blunt or damaged saw blades must not be used.** Bad blades create a narrow cutting groove and cause excessive friction which restricts blade rotation and leads to

rebound.

- f) **The levers for adjusting the depth of cut and the oblique angle of the saw blade must be tightened sufficiently and securely before cutting begins.** If the blade position setting is changed during cutting, the blade may jam and be thrown back.
- g) **Be specially careful when cutting into existing walls or other locations where there is no visibility.** A blade that penetrates to the other side of the material may cut into the object, which may cause rebound.

8.2 SAFETY INSTRUCTIONS FOR SAWS WITH EXTERNAL SWING-OUT COVER.

FUNCTION OF THE LOWER PROTECTIVE COVER







- a) **Before each use, check that the lower protective cover closes properly. Do not operate the saw unless the lower cover moves freely and closes immediately. The lower protective cover must never be secured in the open position, e.g. by clamping or tying.** If the saw is accidentally dropped on the ground, the lower cover may become bent. The lower protective cover must be swung by the lever to ensure that it moves freely and does not touch the saw blade or any other part of the saw at any opening angle or setting depth of cut.
- b) **The spring function of the lower protective cover must be checked. If the function of the cover and return spring is not correct, these parts must be repaired before use.**
- c) **The lower protective cover may only be manually swung away in special cutting situations, such as 'plunge cuts' or 'compound cuts'. The protective cover must be opened by the lever and released after the saw blade penetrates the material.** In all other cutting cases, the lower guard should operate automatically.
- d) **Before placing the saw on the workbench or on the floor, always check that the lower protective cover covers the saw blade.** An unprotected running blade will cause the saw to reverse and cut anything in its path. Be aware of how long it takes for the blade to stop after the switch is off.

9. Storage

Store the cleaned tool in a dry place out of reach of children at temperatures up to 45 °C. Protect the tool from direct sunlight, radiation heat sources, moisture, and water penetration.

10. Meaning of symbols on labels



	Meets relevant EU requirements.
	Electrical waste, see below.
	Second class protection equipment. Double insulation.
	Use certified eye and ear protection with a sufficient level of protection.
	Use certified respiratory protection with adequate level of protection.
	Read the instructions before use.

11. Disposal of waste

Packaging materials

Dispose of packaging materials in the appropriate container for sorted waste.

Unusable saw

According to EU Directive 2012/19, unusable electrical equipment must not be disposed of in municipal waste, but must be submitted for environmentally friendly disposal to the collection of electrical equipment. Information on collection points for electrical equipment and collection conditions can be obtained at the municipal office or from the seller.



EC Declaration of Conformity

Manufacturer Levior s.r.o. • Tovačovská 3488, CZ-750 02 Přerov declares that the subsequently marked devices, based on their concept and construction, as well as the designs listed on the market, meet the requirements of the European Union listed below. This declaration is issued under the sole responsibility of the manufacturer.

Subjects of declaration-product identification:

Product: Hand Held Circular Saw

Model No.: M1Y-DU32-185R

Item No.: 28230

comply with the following harmonized standards, including their amending annexes, if any, by which conformity with the following harmonization provisions is declared:

2006/42/EC:

EN 62841-1:2015; EN 62841-2-5:2014; AfPS GS 2014:01

2014/30/EU:

EN IEC 55014-1:2021; EN IEC 55014-2:2021; EN IEC 61000-3-2:2019+A1;

EN 61000-3-3:2013+A1+A2

2011/65/EU (EU)2015/863

The completion of technical documentation 2006/42/EC was performed by Ondřej Marek with his registered office at the manufacturer's address.

The technical documentation (2006/42/EC) is available at the manufacturer's address.

Place and date of issue of the EC declaration of conformity: Přerov, 30.5.2023

Person authorized to draw up the EC declaration of conformity on behalf of the manufacturer (signature, name, function):

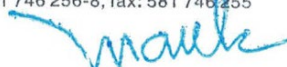
Tovačovská 3488/28, 750 02 Přerov
IČO 61973939 DIČ CZ61973939
tel.: 581 746 256-8, fax: 581 746 255

Ondřej Marek

managing director Levior s.r.o.