

D-Link®

**OUTDOOR 5G UNIT
& ROUTER WI-FI AX1500
DWP-1010KT**

**QUICK
INSTALLATION
GUIDE**

INSTALLATIONSANLEITUNG

GUIDE D'INSTALLATION

INSTALLATIEHANDLEIDING

INSTRUKCJA INSTALACJI

INSTALAČNÍ PŘÍRUČKA

TELEPÍTÉSI SEGÉDLET

GHID DE INSTALARE RAPIDĂ

SPRIEVODCA RÝCHLOU INŠTALÁCIU

CONTENTS OF PACKAGING

CONTENTS



DWP-1010 5G/LTE OUTDOOR UNIT



M15 AX1500 MESH ROUTER



QUICK INSTALLATION GUIDE



POLE MOUNT KIT - STAINLESS CLAMP X 2



WALL MOUNT KIT -
SCREW ANCHOR (M6X25 MM)
SCREWS (M3.5X16 MM)



POE INJECTOR (48V POWER SUPPLY)



AC POWER CABLE FOR POE INJECTOR



M15 POWER ADAPTER 12V/1A



10-METER OUTDOOR RJ45 CABLE



1-METER RJ45 CABLE



WATERPROOF SILICONE CLIP

PRODUCT SETUP

POLE-MOUNT INSTALLATION

1. Preparation: Plug the 10-meter RJ45 cable into the device. Pull the cable through the connector on the waterproof plate.

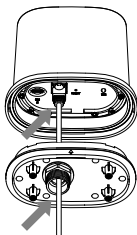

5. Insert the SIM card into the SIM slot (please double-check the sim card size before you put it in).

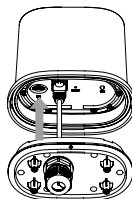

2. Slide the waterproof silicone clip assembly onto the RJ45 cable and press it into the plate.

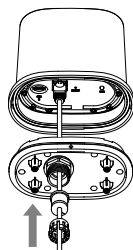

6. Secure the waterproof plate to the device by using the M2.5 x 6mm screws (6 pcs)

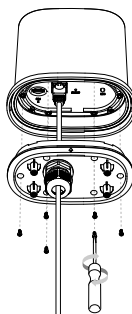

3. Slide the waterproof connector cover onto the silicone clip assembly.

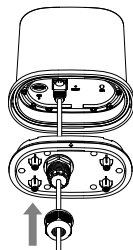

4. Turn the connector cover clockwise to secure it to the plate.

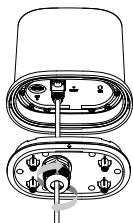

PRODUCT SETUP

POLE-MOUNT INSTALLATION

7. Pull the 10-meter RJ45 cable through the blue base cover and plug it into the PoE port on the PoE injector. Connect the power cable to the PoE injector and plug the power cable into a power source. In the second phase plug 1-meter RJ45 cable from PoE Injector into M15 Internet port. Connect 12V power adapter to power source and M15 router.

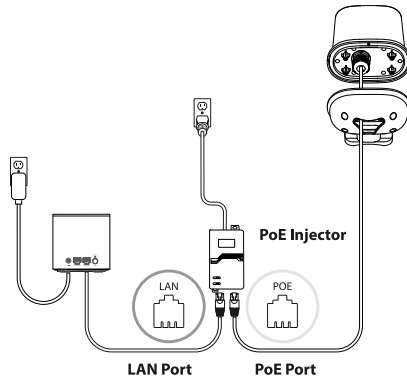

8. Secure the base cover to the DWP-1010 by using the M3 x 4mm screws (4 pcs).

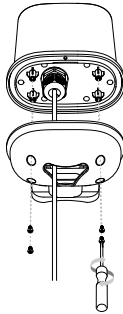

9. Install the stainless steel pipe clips onto the DWP-1010 and loosely secure it to the pole. Open the falcon app and follow the instructions. Lastly, secure the device tightly to the pole.

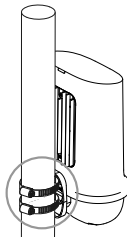

PRODUCT SETUP

WALL-MOUNT INSTALLATION

- Follow steps 1-7 above and power on the DWP-1010. When the LED lights are on, hold the DWP-1010 against the desired location on the wall and adjust position if necessary. When both LED lights are steady blue, it is in a desirable location to receive good signal strength.

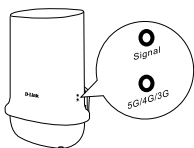

| LED Indications | |
|-----------------------------------|-----------------|
| Connection type LED (Blue+ Green) | |
| No Signal | Off |
| LTE / 3G | Green Steady on |
| 5G | Blue Steady on |
| Signal strength LED (Red + Blue) | |
| No Signal | Red Flash |
| Poor signal | Red Steady on |
| Mid Signal | Blue Flash |
| Good Signal | Blue Steady on |

- After the installation location has been determined, use the wall-mount plate to mark and drill the holes in the wall. Then insert the M6 x 25mm screw anchors (4 pcs) into the wall.

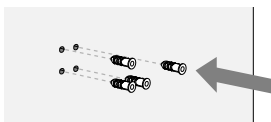

- Secure the wall-mount plate and blue base cover to the wall by using the M3.5 x 16mm screws (4 pcs). Make sure the RJ45 cable is going through the blue base cover.

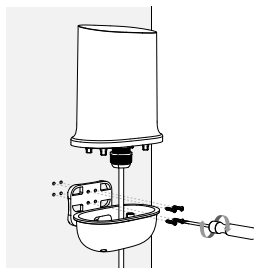

- Secure the DWP-1010 to the wall by using the M3 x 4mm screws (4 pcs).

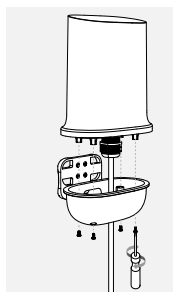

- Installation is complete.

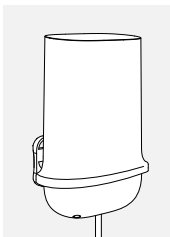

PRODUCT SETUP

GET THE FALCON APP



If your SIM card has active PIN protection, please follow the below instruction, before you start the Falcon APP installation process. Log in to the IDU device via a web browser (default login details) by entering **192.168.0.1**. Go to **External Unit 5G > 5G/LTE Connection** and enter the **PIN Code** in PIN Code field. Click Save.

1. Get the falcon App on the App Store or on Google Play.
2. Use your phone to scan the QR code and establish 5G connection with Wi-Fi 6 mesh ready system.

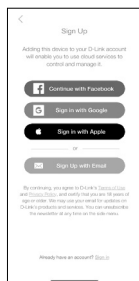

3. Open the falcon app and follow the instructions.

TECHNICAL SUPPORT

dlink.com/support

PAKETINHALT

INHALT



DWP-1010 5G/LTE-OUTDOOR EINHEIT



M15 AX1500 MESH-ROUTER



KURZANLEITUNG ZUR INSTALLATION



MASTMONTAGESATZ - EDELSTAHLKLEMME X 2



WANDMONTAGE-KIT - SCHRAUBANKER
SCHRAUBDÜBEL (M6X25 MM)
SCHRAUBEN (M3,5X16 MM)



POE-INJEKTOR (48-V-STROMVERSORGUNG)



AC-STROMKABEL FÜR POE-INJEKTOR



M15 STROMADAPTER 12V/1A



10-METER-RJ45-KABEL FÜR DEN
AUSSENBEREICH



1-METER-RJ45-KABEL



WASSERDICHTER SILIKONCLIP

HARDWARE INSTALLATION

MASTMONTAGE

1. Vorbereitung: Stecken Sie das 10-Meter-RJ45-Kabel in das Gerät. Ziehen Sie das Kabel durch den Anschluss an der wasserdichten Platte.

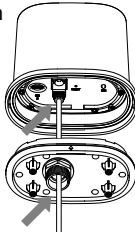

2. Schieben Sie die wasserdichte Silikonklemme auf das RJ45-Kabel und drücken Sie sie in die Platte.

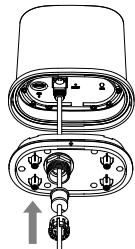

3. Schieben Sie die wasserdichte Steckerabdeckung auf die Silikonklemme.

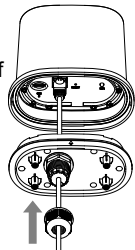

4. Drehen Sie die Steckerabdeckung im Uhrzeigersinn, um sie an der Platte zu befestigen.

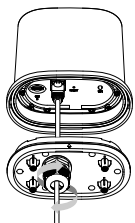

5. Legen Sie die SIM-Karte in den SIM-Slot ein (bitte überprüfen Sie die Größe der SIM-Karte, bevor Sie sie einlegen).

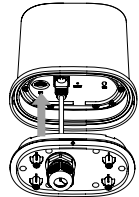

6. Befestigen Sie die wasserdichte Platte mit den M2,5 x 6mm Schrauben (6 Stück) am Gerät.

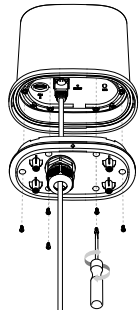

HARDWARE INSTALLATION

POLE-MOUNT INSTALLATION

7. Ziehen Sie das 10-Meter-RJ45-Kabel durch die blaue Basisabdeckung und stecken Sie es in den PoE-Anschluss am PoE-Injektor. Verbinden Sie das Stromkabel mit dem PoE-Injektor und schließen Sie das Stromkabel an eine Stromquelle an. In der zweiten Phase stecken Sie das 1-Meter-RJ45-Kabel vom PoE-Injektor in den M15-Internetanschluss. Schließen Sie das 12V-Netzteil an die Stromquelle und den M15-Router an.

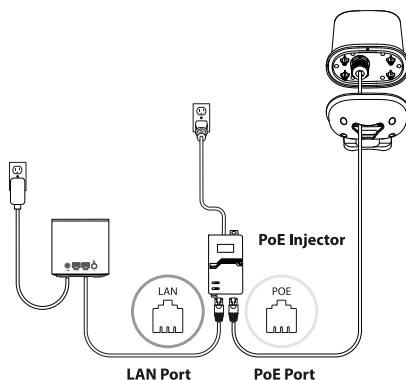

8. Befestigen Sie die Basisabdeckung mit den M3 x 4 mm Schrauben (4 Stück) am DWP-1010.

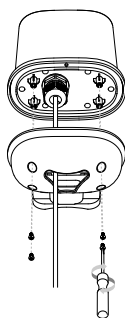

9. Bringen Sie die Edelstahlrohrschellen am DWP-1010 an und befestigen Sie ihn locker am Mast. Öffnen Sie die Falcon App und folgen Sie den Anweisungen. Zum Schluss befestigen Sie das Gerät fest am Mast.

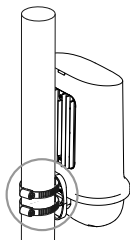

HARDWARE INSTALLATION

WANDBEFESTIGUNG

1. Führen Sie die Schritte 1-7 aus und schalten Sie den DWP-1010 ein. Wenn die LED-Leuchten leuchten, halten Sie den DWP-1010 an die gewünschte Stelle an der Wand und passen Sie die Position gegebenenfalls an. Wenn beide LED-Leuchten konstant blau leuchten, befindet sich der DWP-1010 an bester Stelle, um eine gute Signalstärke zu erhalten.

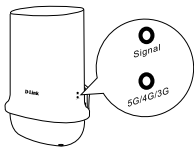

| LED-Anzeigen | |
|---------------------------------|------------------------|
| Verbindungstyp LED (Blau+ Grün) | |
| Kein Signal | Off |
| LTE / 3G | Grün leuchtet konstant |
| 5G | Blau leuchtet konstant |
| Signalstärke LED (Rot + Blau) | |
| Kein Signal | Rotes blinken |
| Schlechtes Signal | Rot dauerhaft an |
| Mittleres Signal | Blaues blinken |
| Gutes Signal | Blau Dauerlicht |

2. Nachdem der Installationsort festgelegt wurde, markieren und bohren Sie mit Hilfe der Wandmontageplatte die Löcher in die Wand. Setzen Sie dann die M6 x 25mm-Schraubanker (4 Stück) in die Wand ein.

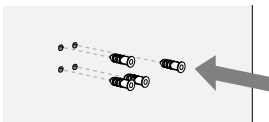

3. Befestigen Sie die Wandmontageplatte und die blaue Basisabdeckung mit den M3,5 x 16 mm Schrauben (4 Stück) an der Wand. Achten Sie darauf, dass das RJ45-Kabel durch die blaue Basisabdeckung geführt ist.

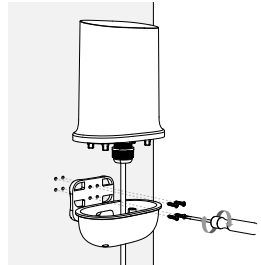

4. Befestigen Sie den DWP-1010 mit den M3 x 4mm Schrauben (4 Stück) an die Wand.

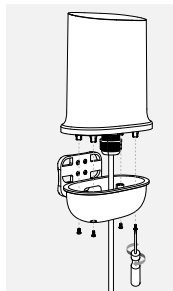

5. Die Installation ist abgeschlossen.

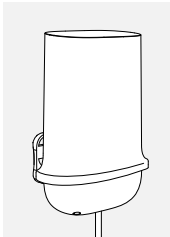

HARDWARE INSTALLATION

HOLEN SIE SICH DIE FALCON APP



1. Die Falcon App im App Store oder bei Google Play herunterladen.
2. Scannen Sie mit Ihrem Telefon den QR-Code und stellen Sie eine 5G-Verbindung mit dem Wi-Fi 6 Mesh Ready System her.

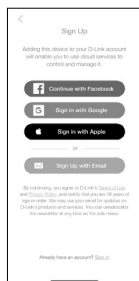

3. Öffnen Sie die Falcon App und folgen Sie den Anweisungen.

Wenn Ihre SIM-Karte über einen aktiven PIN-Schutz verfügt, befolgen Sie bitte die folgenden Anweisungen, bevor Sie mit der Installation der Falcon App beginnen. Melden Sie sich bei der IDU über einen Webbrowser an (Standard-Anmeldedaten), indem Sie **192.168.0.1** eingeben. Gehen Sie zur **Externe Einheit 5G > 5G/LTE-Verbindung** und geben Sie den **PIN-Code** in das Feld PIN-Code ein. Klicken Sie auf **Speichern**.

TECHNISCHE UNTERSTÜTZUNG

dlink.com/support

CONTENU DE LA BOÎTE

TABLE DES MATIÈRES



DWP-1010 UNITÉ EXTÉRIEURE 5G/LTE



ROUTEUR MESH M15 AX1500



GUIDE D'INSTALLATION RAPIDE



KIT DE MONTAGE SUR MÂT - PINCE EN ACIER INOXYDABLE X 2



KIT DE MONTAGE MURAL - ANCRAGE À VIS
CHEVILLES À VISSER (M6X25 MM)
VIS (M3,5X16 MM)



INJECTEUR POE (ALIMENTATION 48 V)



CÂBLE D'ALIMENTATION AC POUR INJECTEUR
POE



ADAPTATEUR D'ALIMENTATION M15
12V/1A



CÂBLE RJ45 DE 10 MÈTRES POUR
L'EXTÉRIEUR



CÂBLE RJ45 DE 1 MÈTRE



CLIP EN SILICONE IMPERMÉABLE

CONFIGURATION DU PRODUIT

MONTAGE SUR MÂT

1. Préparation : branchez le câble RJ45 de 10 mètres dans l'appareil. Tirez le câble à travers le connecteur sur la plaque étanche.

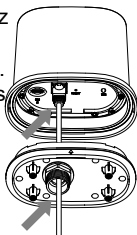

5. insérez la carte SIM dans le slot SIM (veuillez vérifier la taille de la carte SIM avant de l'insérer).

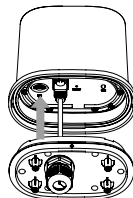

2. Glisser le clip en silicone étanche sur le câble RJ45 et l'enfoncer dans la plaque.

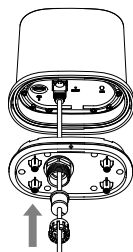

6. Fixez la plaque étanche à l'appareil à l'aide des vis M2,5 x 6mm (6 pièces).

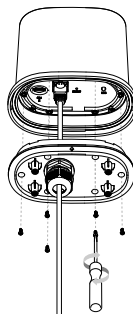

3. Faites glisser le cache-connecteur étanche sur l'attache en silicone

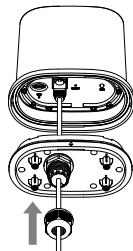

4. Tournez le cache connecteur dans le sens des aiguilles d'une montre pour le fixer au panneau

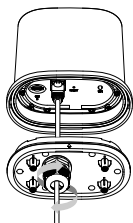

CONFIGURATION DU PRODUIT

MONTAGE SUR MÂT

7. tirez le câble RJ45 de 10 mètres à travers le couvercle de base bleu et branchez-le dans le port PoE de l'injecteur PoE. Connectez le câble d'alimentation à l'injecteur PoE et branchez le câble d'alimentation à une source de courant. Dans la deuxième phase, branchez le câble RJ45 d'un mètre de l'injecteur PoE dans le port Internet M15. Branchez le bloc d'alimentation 12V à la source d'alimentation et au routeur M15.

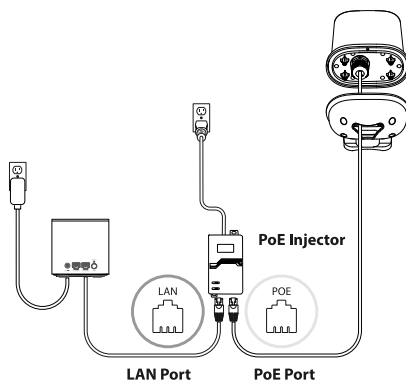

8. Fixez le couvercle de base bleu au DWP-1010 à l'aide des vis M3 x 4 mm (4 pièces).

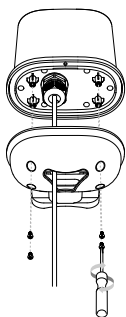

9. Installez les colliers de serrage en acier inoxydable sur le DWP-1010 et fixez-le au mât sans le serrer trop fort. Ouvrez l'application falcon et suivez les instructions. Pour finir, fixez fermement l'appareil au mât.

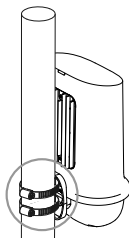

CONFIGURATION DU PRODUIT

WANDBEFESTIGUNG

1. Suivez les étapes 1 à 7 et allumez le DWP-1010. Lorsque les voyants sont allumés, tenez le DWP-1010 à l'endroit souhaité sur le mur et ajustez la position si nécessaire. Si les deux voyants sont bleus en permanence, le DWP-1010 se trouve au meilleur endroit pour obtenir une bonne intensité de signal.

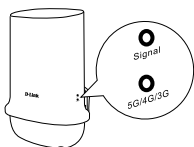

| Indicateurs LED | |
|-------------------------------------|----------------------------|
| Type de connexion LED (bleu + vert) | |
| Pas de signal | Off |
| LTE / 3G | Vert allumé en permanence |
| 5G | Bleu allumé en permanence |
| Force du signal LED (rouge + bleu) | |
| Pas de signal | Rouge clignotant |
| Mauvais signal | Rouge allumé en permanence |
| Signal moyen | Bleu clignotant |
| Bon signal | Bleu fixe |

2. Après avoir déterminé l'emplacement de l'installation, marquez et percez les trous dans le mur à l'aide de la plaque de montage mural. Insérez ensuite les ancrages à vis M6 x 25mm (4 pièces) dans le mur.

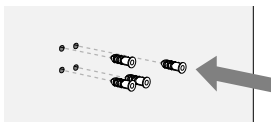

3. Fixez la plaque de montage mural et le couvercle de base bleu au mur à l'aide des vis M3,5 x 16 mm (4 pièces). Veillez à ce que le câble RJ45 passe par le couvercle de base bleu.

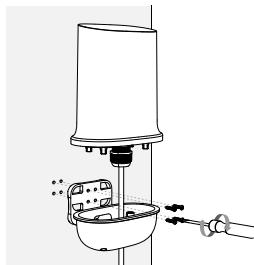

4. Fixez le DWP-1010 au mur à l'aide des vis M3 x 4mm (4 pièces).

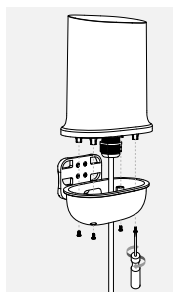

5. l'installation terminée

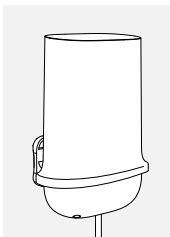

CONFIGURATION DU PRODUIT

PROCUREZ-VOUS L'APPLICATION FALCON



Si votre carte SIM dispose d'une protection PIN active, veuillez suivre les instructions suivantes avant de commencer l'installation du falcon APP. Connectez-vous à l'IDU via un navigateur web (données de connexion par défaut) en saisissant **192.168.0.1**. Allez sur **Unité externe 5G > Connexion 5G/LTE** et saisissez le code PIN dans le champ **Code PIN**.

1. Télécharger l'application falcon dans l'App Store ou sur Google Play.
2. Scannez le code QR avec votre téléphone et établissez une connexion 5G avec le système Wi-Fi 6 Mesh Ready.

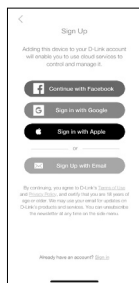

3. Ouvrez l'application falcon et suivez les instructions.

ASSISTANCE TECHNIQUE

dlink.com/support

INHOUD VAN VERPAKKING

INHOUD



DWP-1010 5G/LTE OUTDOOR UNIT



M15 AX1500 MESH ROUTER



SNELLE INSTALLATIEGIDS



PAALMONTAGESET - 2X RVS KLEM



WANDMONTAGESET -
SCHROEFANKER (M6X25 MM)
SCHROEVEN (M3,5X16 MM)



POE INJECTOR (48V POWER SUPPLY)



AC-VOEDINGSKABEL VOOR POE-INJECTOR



M15 VOEDINGSADAPTER 12V/1A



10 METER OUTDOOR RJ45-KABEL



1 METER RJ45-KABEL



WATERDICHTe SILICONEN CLIP

PRODUCTINSTALLATIE

INSTALLATIE MET PAALBEVESTIGING

1. Voorbereiding: Sluit de 10 meter lange RJ45-kabel aan op het apparaat. Trek de kabel door de connector op de waterdichte plaat.

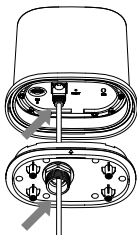

5. Plaats de SIM-kaart in het SIM-slot (controleer de grootte van de SIM-kaart voordat u deze plaatst).

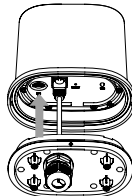

2. Schuif de waterdichte siliconen clip op de RJ45-kabel en druk deze in de plaat.

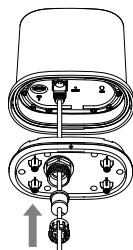

6. Bevestig de waterdichte plaat aan het apparaat met behulp van de M2,5 x 6 mm schroeven (6 stuks)

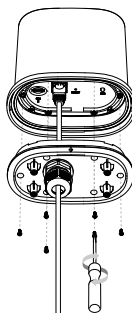

3. Schuif de waterdichte connectorafdekking op de siliconen clipconstructie.

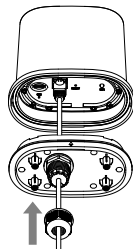

4. Draai de connectordeksel rechtsom om deze op de plaat te bevestigen.

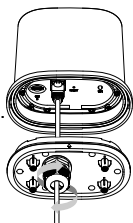

PRODUCTINSTALLATIE

INSTALLATIE MET PAALBEVESTIGING

7. Trek de 10 meter lange RJ45-kabel door de blauwe onderplaat en sluit deze aan op de PoE-poort van de PoE-injector. Sluit de voedingskabel aan op de PoE-injector en steek de voedingskabel in een stopcontact. Steek in de tweede fase de RJ45-kabel van 1 meter van de PoE-injector in de M15-internetpoort. Sluit de 12V-voedingsadapter aan op de stroombron en de M15-router.

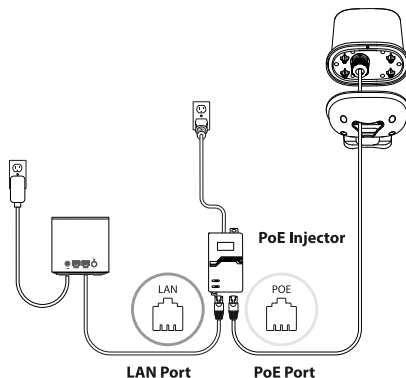

8. Bevestig de onderplaat aan de DWP-1010 met behulp van de M3 x 4 mm schroeven (4 stuks).

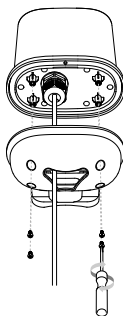

9. Installeer de roestvrijstalen pijpklemmen op de DWP-1010 en bevestig deze losjes aan de paal. Open de falcon App en volg de instructies. Bevestig ten slotte het apparaat stevig aan de paal.

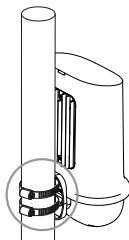

PRODUCTINSTALLATIE

INSTALLATIE VOOR WANDMONTAGE

1. Volg stappen 1-7 hierboven en schakel de DWP-1010 in. Wanneer de LED-lampjes branden, houdt u de DWP-1010 tegen de gewenste locatie op de muur en past u de positie indien nodig aan. Wanneer beide LED-lampjes ononderbroken blauw zijn, bevindt het zich op een gewenste locatie om een goede signaalsterkte te ontvangen.

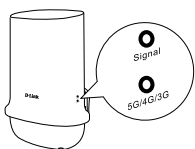

| LED-indicaties | |
|------------------------------------|-------------------|
| Type aansluiting LED (Blauw+Groen) | |
| Geen signaal | Uit |
| LTE / 3G | Groen Continu aan |
| 5G | Blauw Continu aan |
| Signaalsterkte LED (Rood + Blauw) | |
| Geen signaal | Rood Knipperend |
| Slecht signaal | Rood Continu aan |
| Matig signaal | Blauw Knipperend |
| Goed signaal | Blauw Continu aan |

2. Nadat de installatielocatie is bepaald, gebruikt u de muurbevestigingsplaat om de gaten in de muur te markeren en te boren. Steek vervolgens de M6 x 25 mm pluggen (4 stuks) in de muur.

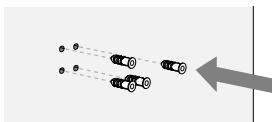

3. Bevestig de wandmontageplaat en de blauwe basisplaat aan de muur met behulp van de M3,5 x 16 mm schroeven (4 stuks). Zorg ervoor dat de RJ45-kabel door de blauwe onderplaat gaat.

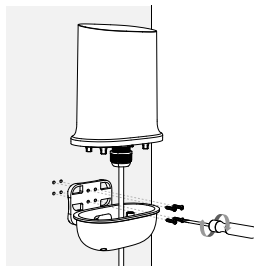

4. Bevestig de DWP-1010 aan de muur met behulp van de M3 x 4 mm schroeven (4 stuks).

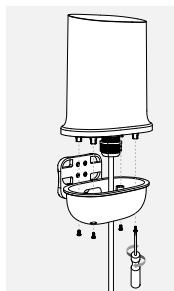

De installatie is voltooid

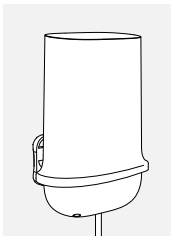

PRODUCTINSTALLATIE

DOWNLOAD DE FALCON APP



Als uw SIM-kaart een actieve PIN-beveiliging heeft, volg dan de onderstaande instructies voordat u het installatieproces van de falcon App start. Log in op het IDU-apparaat via een webbrowser (standaard inloggegevens) door **192.168.0.1** in te voeren. Ga naar **Externe eenheid 5G > 5G/LTE-verbinding** en voer de pincode in het veld Pincode in. Klik op Opslaan.

1. Download de falcon App in de App Store of op Google Play.
2. Gebruik je telefoon om de QR-code te scannen en een 5G-verbinding tot stand te brengen met het Wi-Fi 6 mesh ready-systeem.

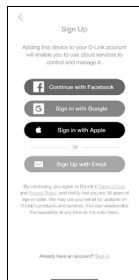

3. Open de falcon App en volg de instructies.

TECHNISCHE ONDERSTEUNING

dlink.com/support

ZAWARTOŚĆ OPAKOWANIA



JEDNOSTKA ZEWNĘTRZNA 5G/LTE DWP-1010



ROUTER MESH AX1500 M15



SKRÓCONA INSTRUKCJA INSTALACJI



MONTAŻ NA SŁUPIE - ZACISK ZE STALI
NIERDZEWNEJ X 2



MONTAŻ ŚCIENNY -
KOTWA ŚRUBOWA (M6X25 MM)
ŚRUBY (M3,5X16 MM)



POE INJECTOR (ZASILANIE 48V)



KABEL ZASILAJĄCY POE INJECTOR



ZASILACZ M15 12V/1A



ZEWNĘTRZNY KABEL RJ-45 O DŁUGOŚCI 10 METRÓW



KABEL RJ-45 O DŁUGOŚCI 1 METRA



GUMOWA USZCZELKA KABLA RJ-45
Z PLASTIKOWYM KLIPSEM

INSTALACJA PRODUKTU

INSTALACJA NA SŁUPIE

1. Przygotowanie:
Przeciągnij kabel przez złącze na wodoodpornej pokrywie. Następnie podłącz 10-metrowy kabel RJ-45 do urządzenia.

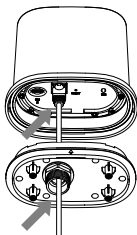

5. Włóż kartę SIM do gniazda SIM (proszę dokładnie sprawdzić rozmiar karty SIM przed jej włożeniem).

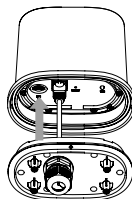

2. Wsuń gumową uszczelkę na kabel RJ-45, następnie umieść na uszczelce plastikowy klips.

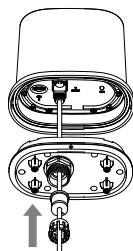

3. Nasuń nakrętkę na gumową uszczelkę i plastikowy klips.

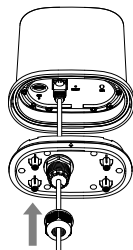

4. Obróć nakrętkę złącza zgodnie z ruchem wskazówek zegara, aby dokręcić ją do pokrywy.

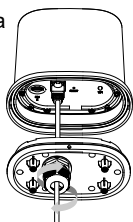

6. Przymocuj wodoodporną pokrywę do urządzenia za pomocą śrub M2,5 x 6mm (6 szt.)

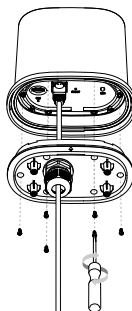

INSTALACJA PRODUKTU

INSTALACJA NA SŁUPIE

7. Przeciągnij 10-metrowy kabel RJ-45 przez niebieską pokrywę dolną i podłącz go do portu PoE na Injektorze PoE. Podłącz kabel zasilający do injektora PoE i podłącz kabel zasilający do źródła zasilania. W drugiej fazie podłącz 1-metrowy kabel RJ-45 z PoE Injector do portu Internet w urządzeniu M15. Podłącz zasilacz 12 V do źródła zasilania routera M15.

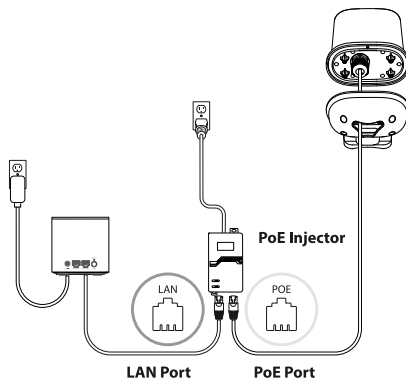

8. Przymocuj pokrywę dolną do DWP-1010 za pomocą śrub M3 x 4mm (4 szt.).

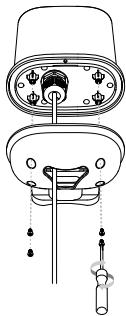

9. Zamontuj obejmy rurowe na DWP-1010 i luźno przymocuj go do słupa. Otwórz aplikację Falcon i postępuj zgodnie z instrukcjami. Na koniec dokręć śruby, aby stabilnie przymocować urządzenie do słupka.

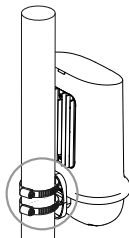

INSTALACJA PRODUKTU

INSTALACJA NAŚCIENNA

1. Należy wykonać kroki 1-7 z poprzednich stron i włączyć DWP-1010. Gdy diody LED są włączone, przyłóż DWP-1010 do żądanego miejsca na ścianie. W razie potrzeby dostosuj położenie. Gdy obie diody LED świecą stałym niebieskim światłem, oznacza to, że znajduje się w pożądanym miejscu, aby odbierać sygnał o dobrej sile.

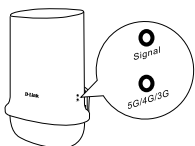

| Diody LED | |
|---|-----------------------|
| Sygnalizowanie połączenia diodą LED (niebieski + zielony) | |
| Brak sygnału | Brak sygnalizacji LED |
| LTE / 3G | Stały zielony kolor |
| 5G | Stały niebieski kolor |
| Siła sygnału LED (czerwony + niebieski) | |
| Brak sygnału | Mruga na czerwono |
| Słaby sygnał | Świeci na czerwono |
| Średni sygnał | Mruga na niebiesko |
| Dobry sygnał | Świeci na niebiesko |

2. Po ustaleniu miejsca instalacji użyj płytki do montażu ściennego, aby zaznaczyć i wywiercić otwory w ścianie. Umieść kołki rozporowe M6x25mm w wywierconych otworach.

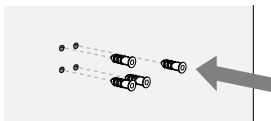

3. Przymocuj płytkę do montażu na ścianie i niebieską pokrywę dolną do ściany za pomocą śrub M3,5x16mm (4 szt.). Upewnij się, że kabel RJ-45 przechodzi przez niebieską pokrywę dolną.

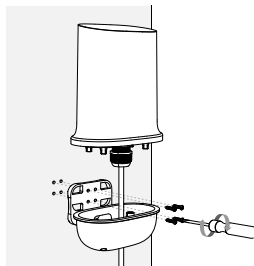

4. Przymocuj DWP-1010 do dolnej pokrywy za pomocą śrub M3x4mm (4 szt.).

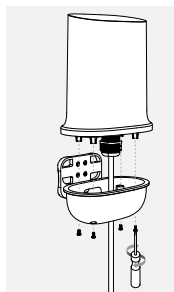

5. Instalacja została zakończona.

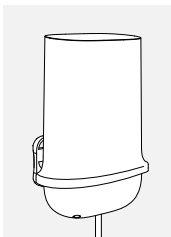

INSTALACJA PRODUKTU

POBIERZ APLIKACJĘ FALCON



1. Pobierz aplikację Falcon ze sklepu App Store lub Google Play.
2. Zeskanuj telefonem kod QR i stwórz sieć Wi-Fi 6 z wykorzystaniem połączenia 5G.

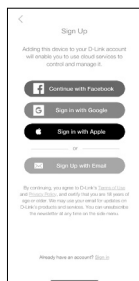

3. Otwórz aplikację Falcon i postępuj zgodnie z instrukcjami.

Jeśli Twoja karta SIM posiada aktywną ochronę PIN, postępuj zgodnie z poniższą instrukcją, zanim rozpoczniesz proces instalacji aplikacji Falcon. Zaloguj się do urządzenia IDU przez przeglądarkę internetową (domyślne dane logowania) wpisując **192.168.0.1**. Przejdź do opcji **Jednostka zewnętrzna 5G > Połączenie 5G/LTE** i wprowadź kod PIN w polu **Kod PIN**. Kliknij Zapisz.

WSPARCIE TECHNICZNE

dlink.com/support

OBSAH BALENÍ

OBSAH



DWP-1010 5G/LTE VENKOVNÍ JEDNOTKA



M15 AX1500 MESH ROUTER



PRŮVODCE RYCHLOU INSTALACÍ



SADA PRO MONTÁŽ NA TYČ - NEREZOVÁ SVORKA X 2



SADA PRO INSTALACI NA STĚNU -
ŠROUBOVÁ KOTVA (M6X25 MM)
ŠROUB (M3.5X16 MM)



POE INJECTOR (ZDROJ 48V)



AC KABEL PRO POE INJECTOR



M15 ZDROJ NAPÁJENÍ 12V/1A



10 METRŮ VENKOVNÍ KABEL RJ45



1 METR KABEL RJ45



VODOTĚSNÁ SILIKONOVÁ SPOJKA

NASTAVENÍ VÝROBKU

INSTALACE NA SLOUP

1. Příprava: Zapojte 10metrový kabel RJ45 do zařízení. Protáhněte kabel konektorem na vodotěsné desce.

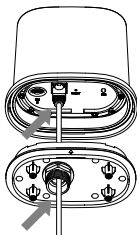

5. Vložte SIM kartu do slotu SIM karty (před vložením zkontrolujte velikost SIM karty).

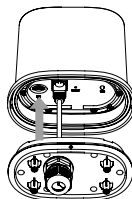

2. Nasuňte sestavu vodotěsné silikonové spojky na kabel RJ45 a zatlačte ji do desky.

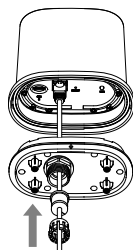

6. Připevněte vodotěsnou desku k zařízení pomocí šroubů M2,5 x 6 mm (6 ks)

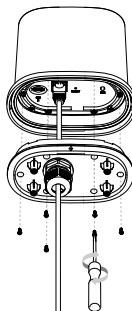

3. Nasuňte vodotěsný kryt konektoru na sestavu silikonové spojky.

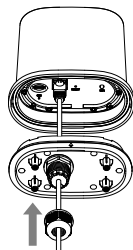

4. Otočte kryt konektoru ve směru hodinových ručiček, abyste jej přitáhli k desce.

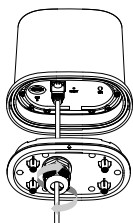

NASTAVENÍ VÝROBKU

INSTALACE NA SLOUP

7. Protáhněte 10metrový kabel RJ45 modrým krytem základny a zapojte jej do PoE portu na PoE injektoru. Připojte napájecí kabel k PoE injektoru a zapojte napájecí kabel do zdroje napájení. Ve druhé fázi zapojte 1metrový kabel RJ45 z PoE injektoru do Internetového portu M15. Připojte 12V napájecí adaptér ke zdroji napájení a routeru M15.

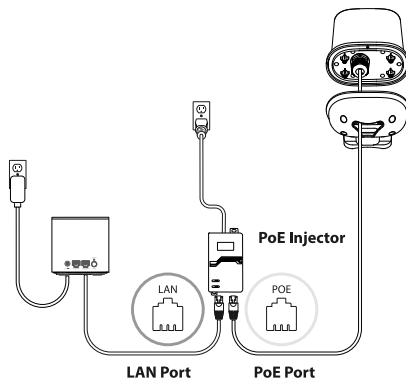

8. Upevněte spodní kryt k DWP-1010 pomocí šroubů M3 x 4 mm (4 ks).

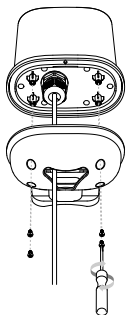

9. Nainstalujte spony z nerezové oceli na DWP-1010 a volně jej připevněte ke sloupu. Otevřete aplikaci Falcon a postupujte podle pokynů. Nakonec zařízení pevně připevněte ke sloupu.

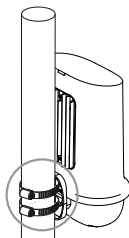

NASTAVENÍ VÝROBKU

INSTALACE NA STĚNU

1. Postupujte podle kroků 1-7 výše a zapněte DWP-1010. Když LED světla svítí, přidržte DWP-1010 na požadovaném místě na stěně a v případě potřeby upravte polohu. Když obě LED kontrolky svítí modře, je na vhodném místě pro příjem dobré síly signálu.

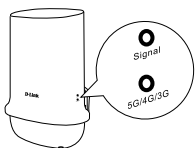

| Indikace LED | |
|------------------------------------|----------------------|
| Typ připojení LED (modrá + zelená) | |
| Bez signálu | Off |
| LTE / 3G | Zelená Svítí trvale |
| 5G | Modrá Svítí trvale |
| LED síla signálu (červená + modrá) | |
| Bez signálu | Červená bliká |
| Slabý signál | Červená Svítí trvale |
| Střední signál | Modrá bliká |
| Dobrý signál | Modrá Svítí trvale |

2. Po určení místa instalace použijte desku pro montáž na stěnu k označení a vyvrtání otvorů ve stěně. Poté vložte do stěny šroubové kotvy M6 x 25 mm (4 ks).

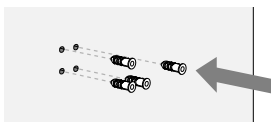

3. Pomocí šroubů M3,5 x 16 mm (4 ks) připevněte desku pro montáž na stěnu a modrý kryt základny ke stěně. Ujistěte se, že kabel RJ45 prochází modrým krytem základny.

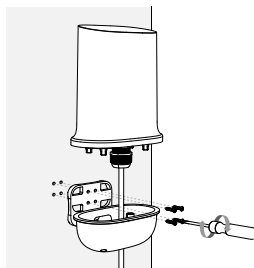

4. Připevněte DWP-1010 ke stěně pomocí šroubů M3 x 4 mm (4 ks).

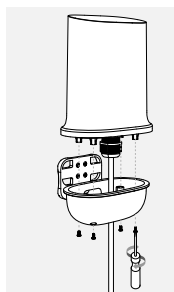

5. Instalace je dokončena.

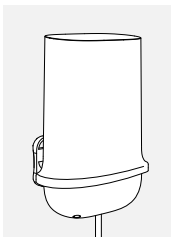

NASTAVENÍ VÝROBKU

STÁHNĚTE SI APLIKACI FALCON



Pokud má vaše SIM karta aktivní ochranu PIN, postupujte před zahájením procesu instalace aplikace Falcon APP podle níže uvedených pokynů. Přihlaste se k zařízení IDU přes webový prohlížeč (výchozí přihlašovací údaje) zadáním **192.168.0.1**. Přejděte na **External Unit 5G > 5G/LTE Connection** a zadejte PIN kód do pole **PIN Code**. Klikněte na **Uložit**.

1. Stáhněte si aplikaci Falcon z App Store nebo Google Play.
2. Pomocí telefonu naskenujte QR kód a navažte 5G připojení se systémem Wi-Fi 6 mesh.

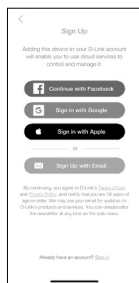

3. Otevřete aplikaci Falcon a postupujte podle pokynů.

TECHNICKÁ PODPORA

dlink.com/support

A CSOMAG TARTALMA

TARTALOM



DWP-1010 5G/LTE KÜLTÉRI EGYSÉG



M15 AX1500 MESH ROUTER



GYORS TELEPÍTÉSI ÚTMUTATÓ



RÖGZÍTŐ KÉSZLET OSZLOPRA TÖRTÉNŐ
RÖGZÍTÉSHEZ (2DB ROZSDAMENTES BILINCS)



RÖGZÍTŐ KÉSZLET FALRA TÖRTÉNŐ RÖGZÍTÉSHEZ
TIPLIK (M6X25 MM)
CSAVAROK (M3.5X16 MM)



POE INJECTOR (48V)



AC TÁPKÁBEL A POE INJECTORHOZ



M15 TÁPEGYSÉG 12V/1A



10 MÉTER KÜLTÉRI RJ45 PATCH KÁBEL



1 MÉTER RJ45 PATCH KÁBEL



VÍZÁLLÓ SZILIKON TÖMÍTÉS

TERMÉKBEÁLLÍTÁS

OSZLOPRA TÖRTÉNŐ TELEPÍTÉS

1. Előkészületek: dugja be a 10 méteres patch kábelt az eszköze, majd húzza át a kábel másik végét a vízálló borításra

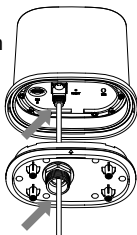

5. Helyezze be a SIM kártyát a SIM foglalatba (kérjük előtte ellenőrizze, hogy a SIM kártya mérete megfelel-e az eszköz által támogatottaknak).

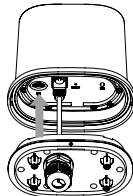

2. Húzza rá a vízálló szilikon tömítést a patch kábelre, majd dugja be a vízálló borításba

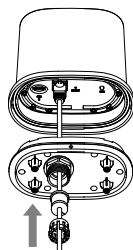

6. A SIM kártya behelyezését követően rögzítse a vízálló bevezetőt az eszközhöz a mellékelt M2.5 csavarok segítségével (6db)

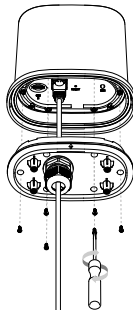

3. Csavarja rá a vízálló csatlakozót a vízálló borításra

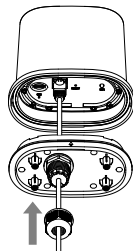

4. Fordítsa a csatlakozó fedelet az óramutató járásával megegyezően hogy rögzítse az eszközön

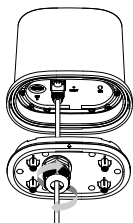

TERMÉKBEÁLLÍTÁS

OSZLOPRA TÖRTÉNŐ TELEPÍTÉS

7. Húzza át a 10 méteres RJ45 kábelt a kék borításon és dugja be a PoE Injector egység PoE portjába. Csatlakoztassa a tápkábelt a PoE Injektorhoz majd dugja be az elektromos hálózatba. Ezt követően az 1 méteres RJ45 patch kábelt csatlakoztassa a PoE Injectorhoz majd az M15 eszköz Internet portjához. Csatlakoztassa a 12V tápegységet az M15 routerhez majd dugja be az elektromos hálózatba.

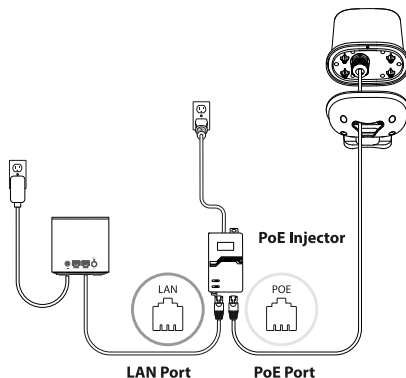

8. Rögzítse az alap fedelet a DWP-1010 eszköz aljára az M3-as csavarokkal (4db).

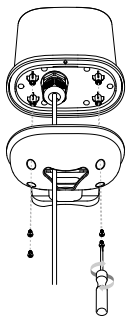

9. Szerelje fel a rozsdamentes acél csőbilincset a DWP-1010-re, és lazán rögzítse az oszlophoz. Nyissa meg a Falcon alkalmazást és kövesse a telepítés további lépéseit. Végül szorosan rögzítse a készüléket a rúdhoz.

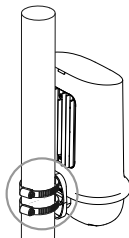

TERMÉKBEÁLLÍTÁS

FALRA TÖRTÉNŐ RÖGZÍTÉS

1. Kövesse a fenti 1-7. lépéseket, és kapcsolja be a DWP-1010-et. Amikor a LED-ek világítanak, tartsa a DWP-1010-et a kívánt helyhez a falon ahova rögzíteni szeretné, és szükség esetén állítsa be a pozíciót. Ha mindkét LED folyamatosan kéken világít, akkor az eszköz megfelelő helyen van és jó a vételi jelerősség.

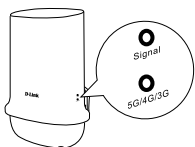

| LED jelzések | |
|-----------------------------------|-------------------------------|
| Csatlakozás típusa LED (kék+zöld) | |
| Nincs jel | Off |
| LTE / 3G | Zöld Folyamatosan bekapcsolva |
| 5G | Kék Folyamatosan bekapcsolva |
| Jelerősség LED (piros + kék) | |
| Nincs jel | Piros villogás |
| Gyenge jel | Piros folyamatosan világít |
| Közepes jel | Kék villogás |
| Jó jel | Kék Folyamatosan bekapcsolva |

2. A beépítési hely meghatározása után a fali rögzítőlappal jelölje meg és fúrja ki a lyukakat a falon. Ezután rögzítse az eszközt az M6-os csavarokkal (4db)

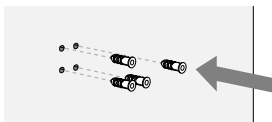

2. A beépítési hely meghatározása után a fali rögzítőlappal jelölje meg és fúrja ki a lyukakat a falon. Ezután rögzítse az eszközt az M6-os csavarokkal (4db)

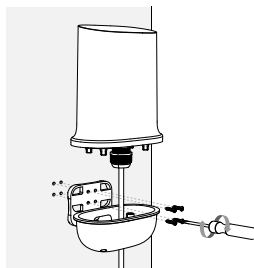

4. Rögzítse a DWP-1010-et a falhoz az M3 x 4 mm-es csavarokkal (4 db).

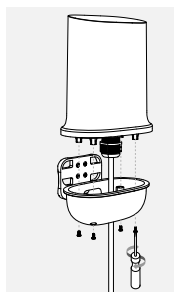

5. Installation is complete.

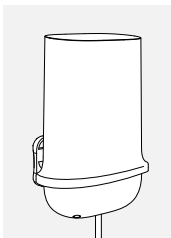

TERMÉKBEÁLLÍTÁS

NYISSA MEG A FALCON ALKALMAZÁST



1. Szerezze be a falcon alkalmazást az App Store-ból vagy a Google Playről.
2. Használja telefonját a QR-kód beolvasásához, és kapcsolódjon a Wi-Fi 6 Mesh rendszerhez.

Amennyiben a SIM kártya PIN kód védelme bekapcsolt állapotban van, kérjük kövesse az alábbi utasításokat mielőtt megnyitja a Falcon APP telepítő folyamatát. Jelentkezzen be a kültéri egységbe egy web böngésző segítségével az alapértelmezett bejelentkezési adatokkal a **192.168.0.1** címet megnyitva. Navigáljon az **External Unit 5G > 5G/LTE Connection** menüpontra majd adja meg a SIM kártyához tartozó **PIN kódot**. Ezt követően kattintson a Save (Mentés) gombra.

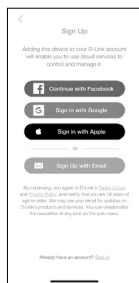

3. Nyissa meg a Falcon alkalmazást és kövesse a telepítés további lépéseit

TECHNIKAI TÁMOGATÁS

dlink.com/support

CONȚINUTUL PACHETULUI

CUPRINS



MODEM 5G/LTE DE EXTERIOR: DWP-1010



ROUTER M15 AX1500 MESH



GHID DE INSTALARE RAPIDĂ



KIT DE MONTARE PE STÂLP - CLEMĂ DIN OTEL INOXIDABIL X 2



KIT DE MONTARE PE PERETE -
DIBLU (M6X25 MM)
ȘURUBURI (M3.5X16 MM)



INJECTOR POE (SURSĂ DE ALIMENTARE 48V)



CABLU ALIMENTARE INJECTOR POE



ALIMENTATOR PENTRU ROUTER M15 (12VDC/1A)



10 METRII DE CABLU DE REȚEA
PENTRU MONTARE LA EXTERIOR



1 METRU DE CABLU DE REȚEA



PRESETUPĂ SILICONICĂ PENTRU
IMPERMEABILIZARE

CONFIGURAREA PRODUSULUI

INSTALARE PE STÂLP

1. Pregătire: Conectați cablul de rețea de 10 metri la dispozitiv. Trageți cablul prin suportul de impermeabilizare

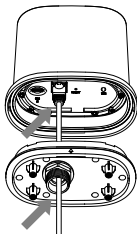

5. Introduceți cartela SIM în slotul SIM (vă rugăm să verificați dacă dimensiunea cartelei SIM este cea potrivită înainte de a o introduce).

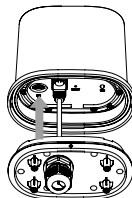

2. Glisați ansamblul presetepei din silicon pe cablul de rețea și apăsați-l în suport.

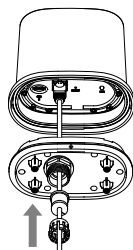

6. Fixați placa impermeabilă la dispozitiv folosind șuruburile M2,5 x 6 mm (6 buc)

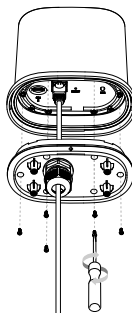

3. Glisați capacul conectorului pe ansamblul clemei din silicon.

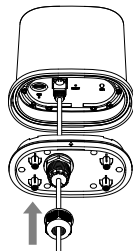

4. Rotiți capacul conectorului în sensul acelor de ceasornic pentru a-l fixa pe placă.

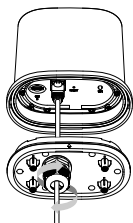

CONFIGURAREA PRODUSULUI

INSTALARE PE STÂLP

7. Trageți cablul de rețea de 10 metri prin capacul albastru al bazei și conectați-l la portul PoE de pe injectorul PoE. Conectați cablul de alimentare la injectorul PoE și conectați cablul de alimentare la o sursă de alimentare. În a doua fază, conectați cablul de rețea de 1 metru de la injectorul PoE în portul de internet al routerului M15. Conectați adaptorul de alimentare de 12 Vdc la sursa de alimentare și la routerul M15.

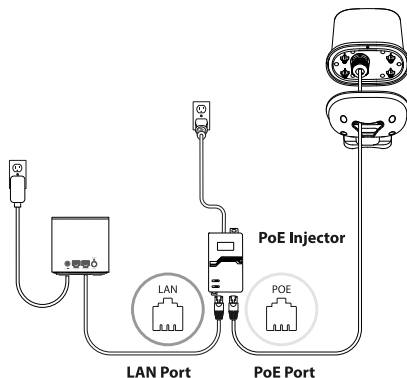

8. Fixați capacul bazei pe DWP-1010 folosind șuruburile M3 x 4 mm (4 bucăți).

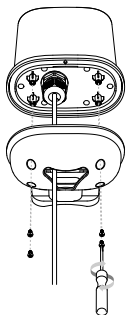

9. Instalați clemele din oțel inoxidabil pe DWP-1010 și fixați-l fără a strânge foarte tare pe stâlp. Deschideți aplicația Falcon și urmați instrucțiunile. În cele din urmă, fixați dispozitivul strâns pe stâlp.

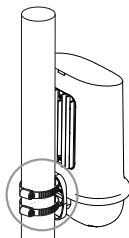

CONFIGURAREA PRODUSULUI

INSTALAREA PE PERETE

1. Urmăți pașii 1-7 de mai sus și porniți DWP-1010. Când luminile LED sunt aprinse, țineți DWP-1010 pe locația dorită de pe perete și ajustați poziția dacă este necesar. Când ambele lumini LED sunt albastre continuu locația este cea potrivită pentru recepția bună a semnalului.

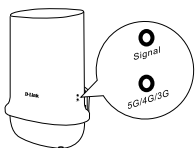

| Semnificația luminilor LED | |
|--------------------------------------|---------------------------------|
| LED tip conexiune (Albastru + Verde) | |
| Semnal inexistent | Off |
| LTE / 3G | Verde aprins permanent |
| 5G | Albastru aprins permanent |
| LED putere semnal (Roșu + Albastru) | |
| Semnal inexistent | Roșu se aprinde intermitent |
| Semnal slab | Roșu aprins permanent |
| Semnal calitate medie | Albastru se aprinde intermitent |
| Semnal bun | Albastru aprins permanent |

2. După ce a fost determinată locația de instalare, utilizați placa de montare pe perete pentru a marca și a realiza găurile în perete. Apoi introduceți diblurile cu șuruburi M6 x 25 mm (4 bucăți) în perete.

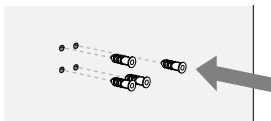

3. Fixați placa de montare pe perete și capacul de bază albastru pe perete folosind șuruburi M3,5 x 16 mm (4 bucăți). Asigurați-vă că cablul de rețea trece prin capacul albastru al bazei.

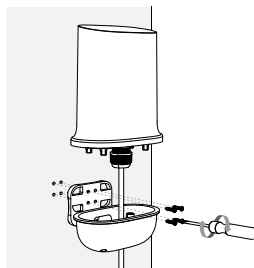

4. Fixați DWP-1010 pe perete folosind șuruburi M3 x 4 mm (4 buc).

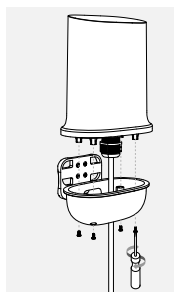

5. Instalarea este finalizată.

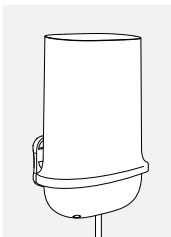

CONFIGURAREA PRODUSULUI

INSTALAȚI APLICAȚIA FALCON PE TELEFON



Dacă cartela SIM are protecție PIN activă, vă rugăm să urmați instrucțiunile de mai jos înainte de a începe procesul de instalare a aplicației Falcon. Conectați-vă la dispozitivul IDU printr-un browser web (detalii de conectare implicite) introducând **192.168.0.1**. **Accesați Unitatea externă 5G > Conexiune 5G/LTE** și introduceți codul PIN în câmpul **Cod PIN**. Faceți clic pe **Salvare**.

1. Obțineți aplicația Falcon din App Store sau din Google Play.
2. Utilizați telefonul pentru a scana codul QR și pentru a stabili conexiunea 5G cu sistemul Mesh Wi-Fi 6.

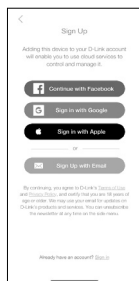

3. Deschideți aplicația Falcon și urmați instrucțiunile.

SUPPORT TEHNIC

dlink.com/support

PACKAGE CONTENTS

OBSAH BALENIA



DWP-1010 5G/LTE VONKAJŠIA JEDNOTKA



M15 AX1500 MESH ROUTER



SPRIEVODCA RÝCHLOU INŠTALÁCIU



SÚPRAVA NA MONTÁŽ NA TYČ - NEREZOVÁ
SVORKA X 2



SÚPRAVA NA INŠTALÁCIU NA STENU -
SKRUTKOVÁ KOTVA (M6X25 MM)
SKRUTKA (M3.5X16 MM)



POE INJECTOR (ZDROJ 48V)



AC KÁBEL PRE POE INJECTOR



M15 ZDROJ NAPÁJANIA 12V/1A



10 METROV VONKAJŠÍ KÁBEL RJ45



1 METER KÁBEL RJ45



VODOTESNÁ SILIKÓNOVÁ SPOJKA

PRODUCT SETUP

INŠTALÁCIA NA STĽP

1. Príprava: Zapojte 10 metrový kábel RJ45 do zariadenia. Pretiahnite kábel konektorom na vodotesnej doske.

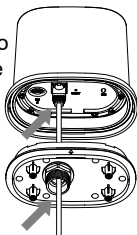

5. Vložte SIM kartu do slotu SIM karty (pred vložením skontrolujte veľkosť karty SIM).

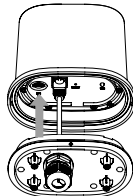

2. Nasuňte zostavu vodotesnej silikónovej spojky na kábel RJ45 a zatlačte ju do dosky.

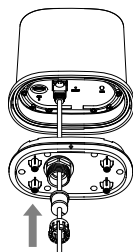

6. Pripevnite vodotesnú dosku k zariadeniu pomocou skrutiek M2,5 x 6 mm (6 ks)

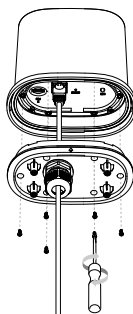

3. Nasuňte vodotesný kryt konektora na zostavu silikónovej spojky.

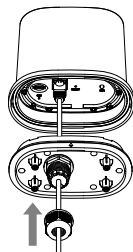

4. Otočte kryt konektora v smere hodinových ručičiek, aby ste ho pritiahli k doske.

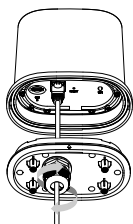

PRODUCT SETUP

INŠTALÁCIA NA STĽP

7. Pretiahnite 10 metrový kábel RJ45 modrým krytom základne a zapojte ho do PoE portu na PoE injektore. Pripojte napájací kábel k PoE injektoru a zapojte napájací kábel do zdroja napájania. V druhej fáze zapojte 1 metrový kábel RJ45 z PoE injektora do Internetového portu M15. Pripojte 12V napájací adaptér k zdroju napájania a routeru M15.

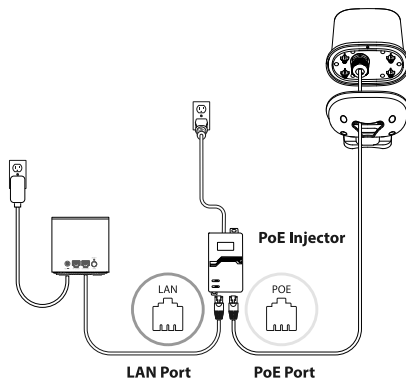

8. Upevnite spodný kryt k DWP-1010 pomocou skrutiek M3 x 4 mm (4 ks).

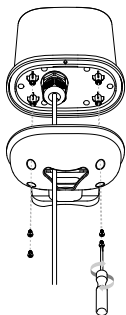

9. Nainštalujte spony z nerezovej ocele na DWP-1010 a voľne ho pripevnite k stĺpu. Naskenujte QR kód zo štítku zariadenia M15 pomocou mobilného zariadenia a pripojte sa k DWP-1010. Otvorte aplikáciu Falcon a upravte polohu zariadenia na optimalizáciu kvality signálu. Nakoniec zariadenie pevne pripevnite k stĺpu.

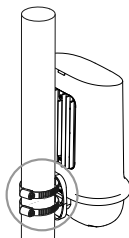

PRODUCT SETUP

INŠTALÁCIA NA STENU

1. Postupujte podľa krokov 1-7 vyššie a zapnite DWP-1010. Keď LED svetlá svietia, pridržte DWP-1010 na požadovanom mieste na stene, v prípade potreby upravte polohu. Keď obe LED kontrolky svietia na modro znamená, že je na vhodnom mieste pre príjem dobrej sily signálu.

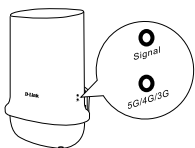

| LED Indikácie | |
|-------------------------------------|----------------------|
| Typ pripojenia LED (modrá + zelená) | |
| Bez signálu | Off |
| LTE / 3G | Zelená Svetí trvalo |
| 5G | Modrá Svetí trvalo |
| LED sila signálu (červená + modrá) | |
| Bez signálu | Červená bliká |
| Slabý signál | Červená Svetí trvalo |
| Stredný signál | Modrá bliká |
| Dobrý signál | Modrá Svetí trvalo |

2. Po určení miesta inštalácie použite dosku pre montáž na stenu na označenie a vyvrtanie otvorov v stene. Potom vložte do steny skrutkovej kotvy M6 x 25 mm (4 ks).

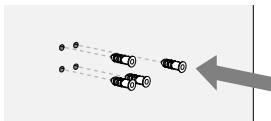

3. Pomocou skrutiek M3,5 x 16 mm (4 ks) pripevníte dosku pre montáž na stenu a modrý kryt základne k stene. Uistite sa, že kábel RJ45 prechádza modrým krytom základne.

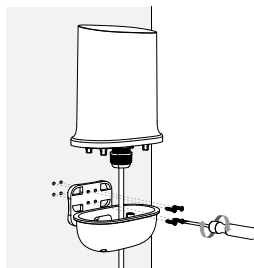

4. Pripevnite DWP-1010 k stene pomocou skrutiek M3 x 4 mm (4 ks).

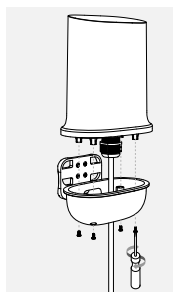

5. Inštalácia je dokončená.

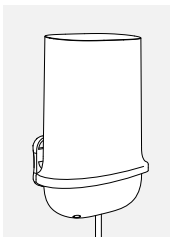

PRODUCT SETUP

STIAHNITE SI APLIKÁCIU FALCON



1. Stiahnite si aplikáciu Falcon z App Store alebo Google Play.
2. Pomocou telefónu naskenujte QR kód a nadviažte 5G pripojenie so systémom Wi-Fi 6 mesh.

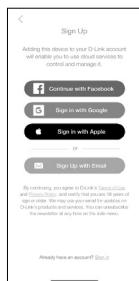

3. Otvorte aplikáciu Falcon a postupujte podľa pokynov.

Ak má vaša SIM karta aktívnu ochranu PIN kódom, tak pred spustením inštaláčného procesu v aplikácii FALCON dodržujte prosím nižšie uvedené pokyny. Prihláste sa do zariadenia IDU cez webový prehliadač (predvolené prihlasovacie údaje) zadaním adresy 192.168.0.1 Prejdite na externú jednotku, položka 5G > 5G/LTE pripojenie a zadejte PIN kód PIN C. Kliknite na tlačidlo Uložiť.

TECHNICAL SUPPORT

dlink.com/support

